

*The journey becomes easy
when your co-traveller
is an expert.*

International Range

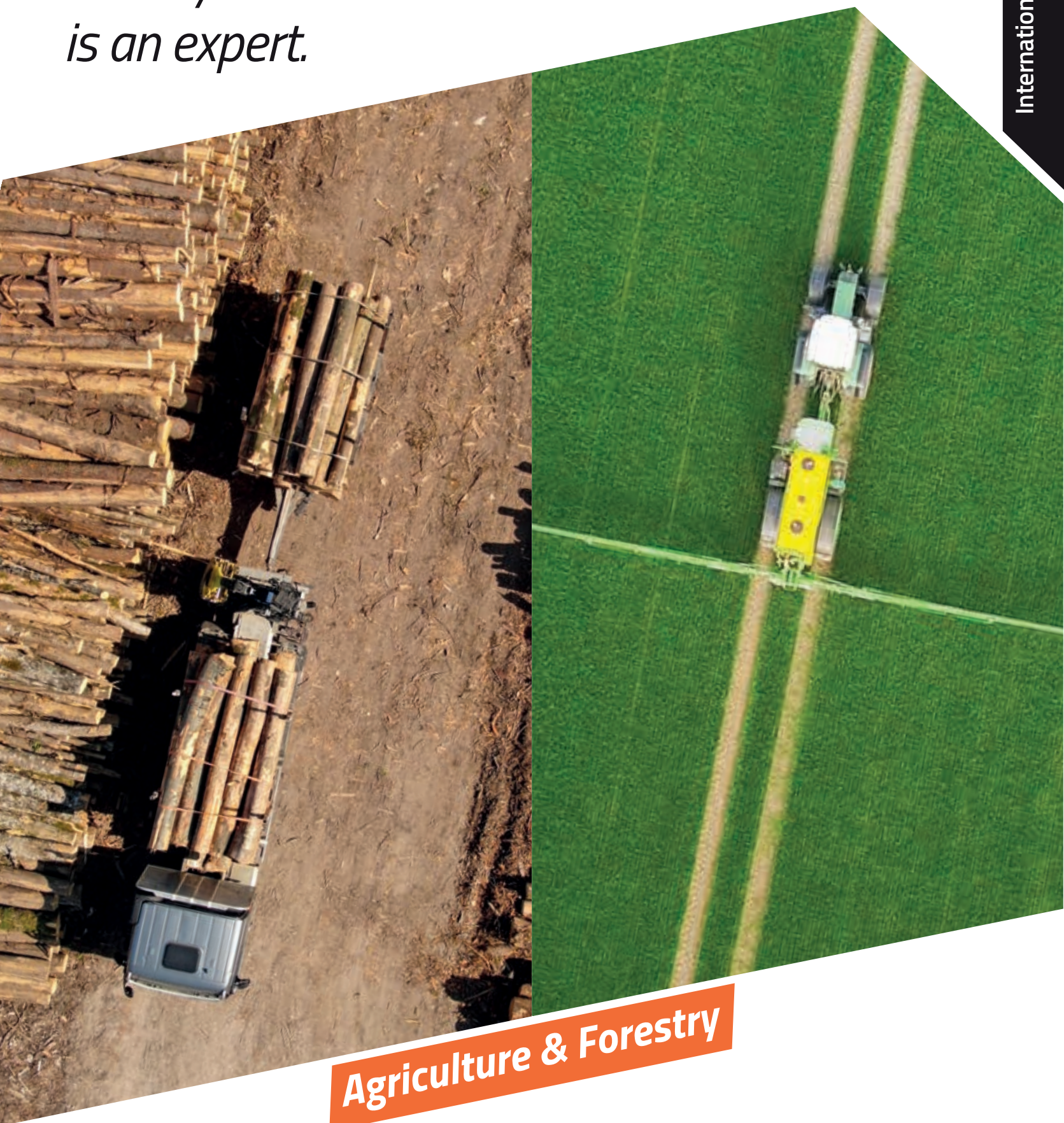

Agriculture & Forestry



Doing business is a journey.
Sometimes you just cruise on, sometimes the going gets tough. When it does, you need an expert.

An expert who helps you rise above obstacles and take your business to newer heights.

Presenting Ascenso off-highway tyres.

Designed keeping in mind absolutely everything: vehicle types, terrain, weather conditions and category needs. Our expertise comes from our vast experience in the tyre business.

We have a total experience of about three decades in the off-highway tyre business. Ascenso is our third off-highway tyre venture, after having launched two successful off-highway tyre brands in the past.

Let's begin our journey together. Welcome aboard!

**The word 'We' refers to the Mahansaria family.*



Never stop learning.
Never stop improving.
Never stop growing.
Never stop rising!

Our Brand Beliefs

- **Customer first**
- **Long term partnership**
- **Competitive and world class**
- **High on value products**
- **Wide and growing range**
- **Tyres for specific application**
- **Consistent quality**



Our Core Values

Ownership

Respect

Agility

Never give up

Go getter, go together

Empathetic

A. Patterns, Markings and Definitions

Patterns	08
Tyre Size Markings	12
Load Index and Speed Symbols	15
Tyre Sidewall Marking and Structures	16
Product Nomenclature	17
Abbreviation	18

B. Agriculture

Tractor

TRACTOR STEER BIAS

TSB 110	21
TSB 111	23
TSB 112	24
BOSS TS 10	25

TRACTOR DRIVE BIAS

TDB 120	26
TDB 121	30
TDB 123	31
TDB 124	32
BOSS TD 15	33

TRACTOR DRIVE RADIAL

XLR 880	34
TDR 650	36
TDR 700	38
TDR 800	40
TDR 850	41

COMPACT DRIVE RADIAL

CDR 700	44
---------------	----

TRACTOR DRIVE RADIAL

TDR 900	45
VDR 900	47
VDR 901	49

MULTI DRIVE RADIAL

MDR 1000	50
----------------	----

Harvester

BIAS

HRB 210	53
---------------	----

RADIAL

HRR 200	54
---------------	----

Implement

BIAS

IMB 160	57
---------------	----

IMB 161	59
---------------	----

IMB 162	61
---------------	----

IMB 163	63
---------------	----

IMB 164	64
---------------	----

IMB 165	65
---------------	----

IMB 166	66
---------------	----

BOSS TR 20	67
------------------	----

BOSS TR 21	68
------------------	----

RADIAL

IMR 140	69
---------------	----

VIR 2500	70
----------------	----

SPR 250	71
---------------	----

Flotation

BIAS

FTB 190	73
---------------	----

RADIAL

FTR 170	75
---------------	----

Irrigation

BIAS

IRB 260	78
---------------	----

Telehandler

BIAS

THB 230	80
---------------	----

THB 230 HD	81
------------------	----

Multi-Purpose

BIAS

SPB 260	83
---------------	----

RADIAL

MPR 390	84
---------------	----

Lawn & Garden

RADIAL	
UTR 240	86

C. Forestry

Agro Forestry

BIAS	
AFB 820	90
AFB 821	91

Log Skidder

BIAS	
LSB 780	93

Forestry Forwarder

BIAS	
FFB 840	96

D. Tyre Care and Usage Manual

Tyre Description	98
Conversion Table	99
Tyre Care And Maintenance	100
Fitting And Removal Instructions	101
Parameter For Extending Tyre Life	103
Rim And Wheel Discs	105
EAN Numbers	107
Warranty	117

Tractor



Tractor



VDR 900
Page No. 47



VDR 901
Page No. 49



MDR 1000
Page No. 50

Harvester



HRB 210
Page No. 53



HRR 200
Page No. 54

Implement



IMB 160
Page No. 57



IMB 161
Page No. 59



IMB 162
Page No. 61



IMB 163
Page No. 63



IMB 164
Page No. 64



IMB 165
Page No. 65



IMB 166
Page No. 66



BOSS TR 20
Page No. 67

Implement



Flotation



Irrigation



Telehandler



Multi-Purpose



Lawn & Garden



2. Forestry

Agro Forestry



Log Skidder



Forestry Forwarder



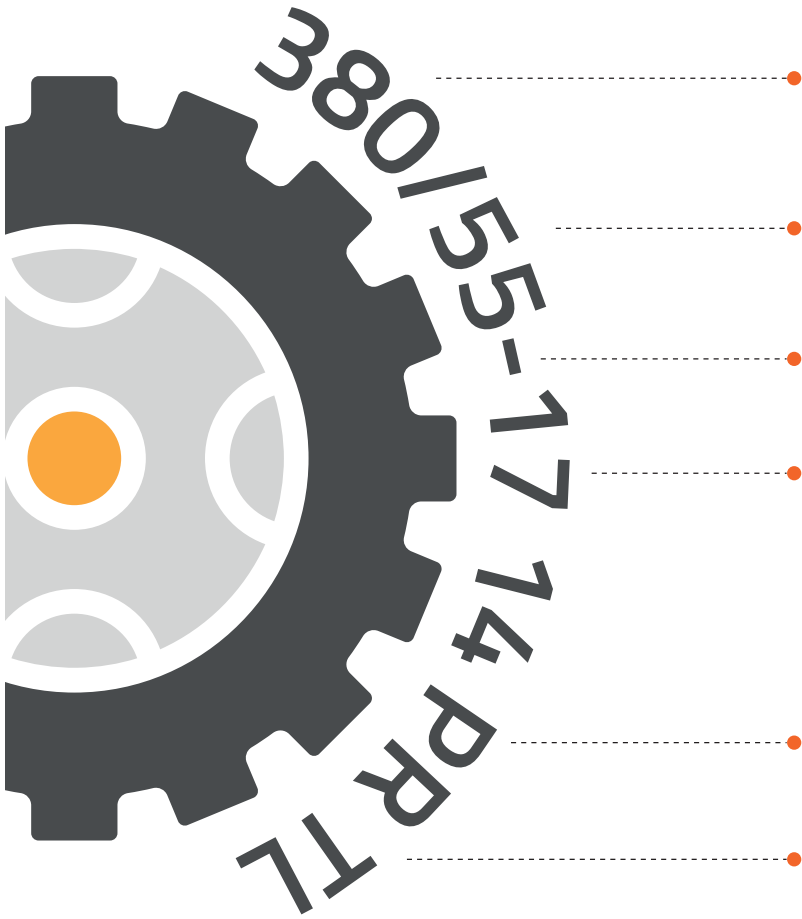

Nominal Section Width
(in mm)

Aspect Ratio (SH/SW) in %

Type Construction (Bias)

Nominal Rim Diameter
(in inches)

Ply Rating

Tubeless

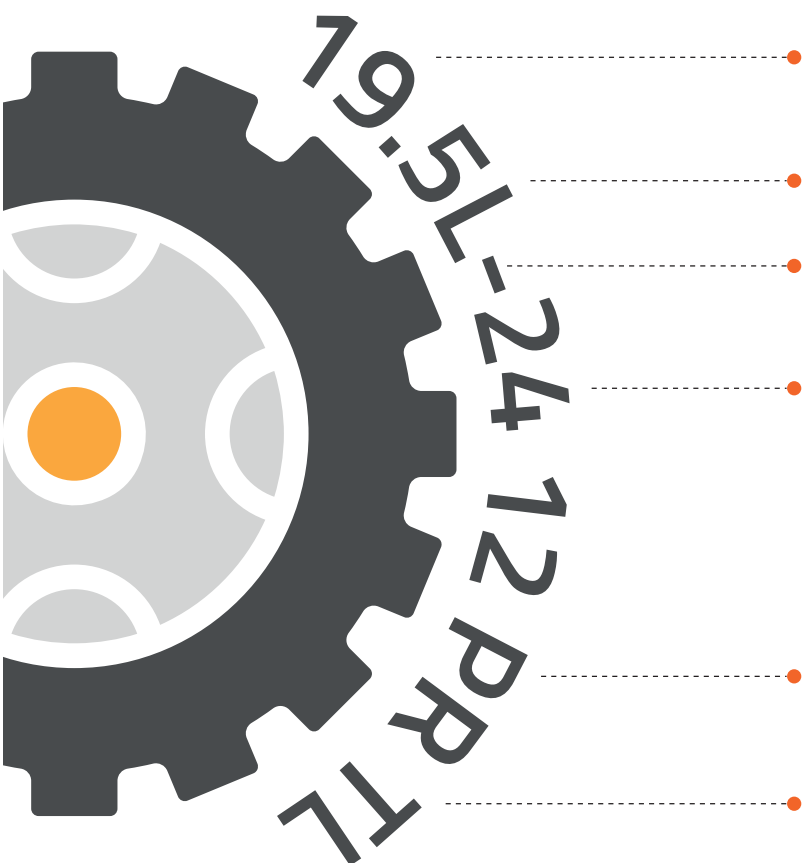

Nominal Section Width
(in inches)

Reduced Aspect Ratio

Type Construction (Bias)

Nominal Rim Diameter
(in inches)

Ply Rating

Tubeless

3. Tyre Size Markings

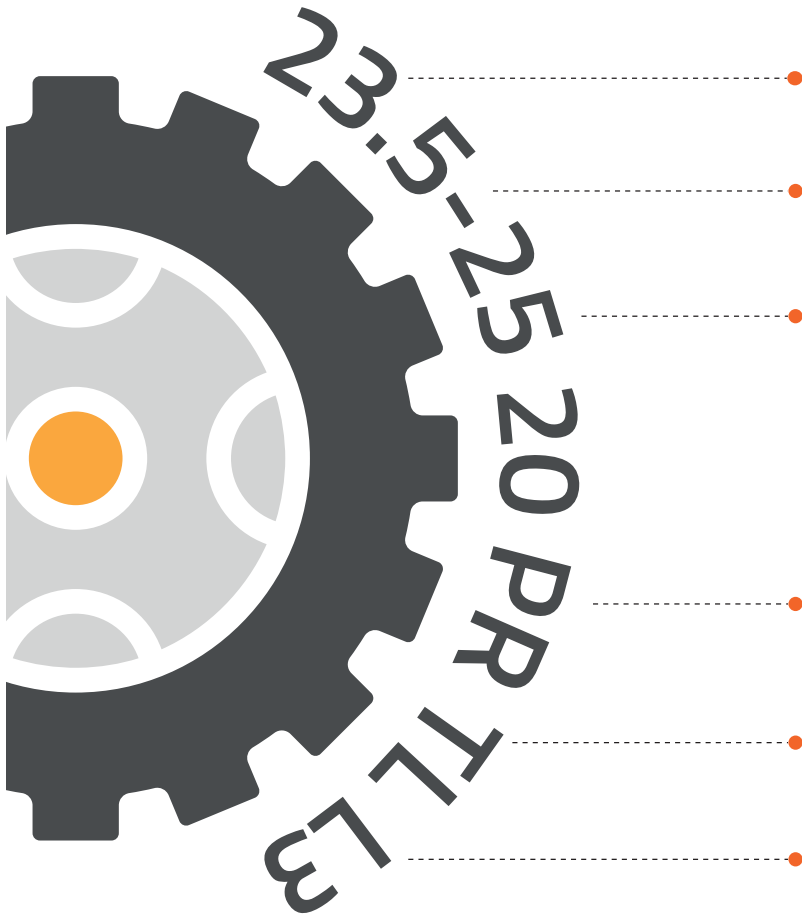

Nominal Section Width
(in inches)

Type Construction (Bias)

Nominal Rim Diameter
(in inches)

Ply Rating

Tubeless

T&RA Code

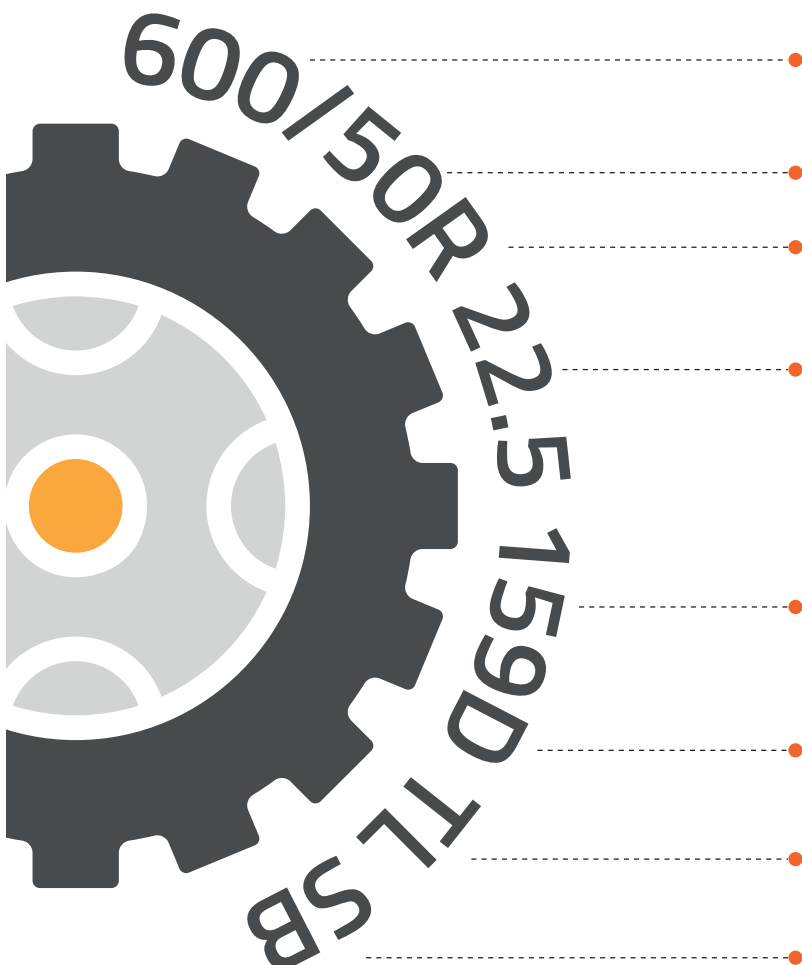

Nominal Section Width
(in mm)

Aspect Ratio (SH/SW) in %

Type Construction (Radial)

Nominal Rim Diameter
(in inches)

Load Index

Speed Rating

Tubeless

Steel Belted

3. Tyre Size Markings

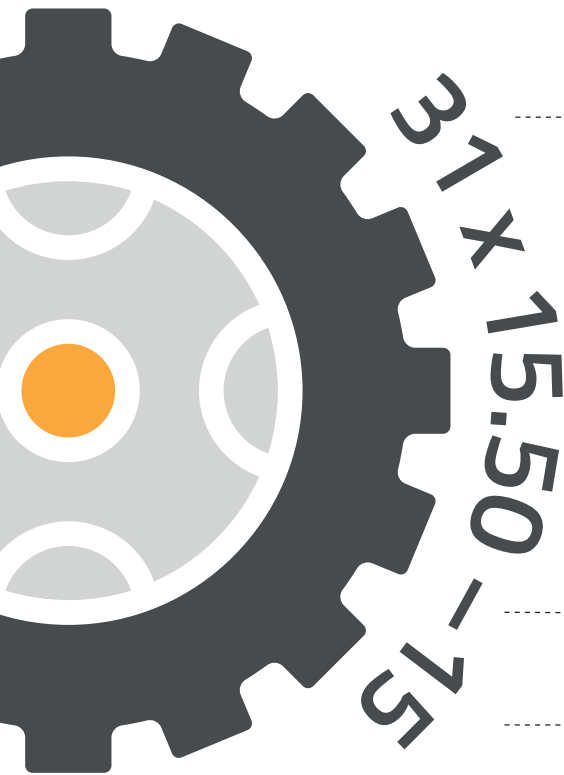

Overall diameter
(in inches)

Nominal section width
(in inches)

Cross-ply construction

Nominal Rim Diameter
(in inches)

4. Load Index and Speed Symbols

According to ETRTO (The European Tyre and Rim Technical Organization), as well as to ECE (Economic Commission for Europe-UN Institution Geneva), the maximum load capacity, as well as the maximum speed are indicated by load index and speed symbol.

The following table shows the meaning of each speed symbol and the load in kg/lbs corresponding to each load index.

Load Index	Load Kg / lbs	Load Index	Load Kg / lbs	Load Index	Load Kg / lbs	Load Index	Load Kg / lbs	Speed Symbol	Kmph / mph
50	190/419	90	600/1323	130	1900 / 4189	170	6000 / 13228	A1	5 / 3
51	195/430	91	615/1356	131	1950 / 4299	171	6150 / 13558	A2	10 / 6
52	200/441	92	630/1389	132	2000 / 4409	172	6300 / 13889	A3	15 / 9
53	206/454	93	650/1433	133	2060 / 4541	173	6500 / 14330	A4	20 / 12
54	212/467	94	670/1477	134	2120 / 4670	174	6700 / 14771	A5	25 / 16
55	218/481	95	690/1521	135	2180 / 4806	175	6900 / 15212	A6	30 / 19
56	224/494	96	710/1566	136	2240 / 4938	176	7100 / 15653	A7	35 / 22
57	230/507	97	730/1610	137	2300 / 5071	177	7300 / 16093	A8	40 / 25
58	236/520	98	750/1654	138	2360 / 5203	178	7500 / 16534	B	50 / 31
59	243/536	99	775/1709	139	2430 / 5357	179	7750 / 17086	C	60 / 37
60	250/551	100	800/1765	140	2500 / 5511	180	8000 / 17637	D	65 / 40
61	257/567	101	805/1820	141	2575 / 5677	181	8250 / 18188	E	70 / 44
62	265/584	102	850 / 1874	142	2650 / 5842	182	8500 / 18739	F	80 / 50
63	272/600	103	875 / 1929	143	2725 / 6007	183	8750 / 19290	G	90 / 56
64	280/617	104	900 / 1984	144	2800 / 6173	184	9000 / 19841	J	100 / 62
65	290/639	105	925 / 2039	145	2900 / 6393	185	9250 / 20392	K	110 / 68
66	300/662	106	950 / 2094	146	3000 / 6614	186	9500 / 20944	L	120 / 75
67	307/667	107	975 / 2149	147	3075 / 6779	187	9750 / 21495	M	130 / 81
68	315/695	108	1000 / 2205	148	3150 / 6944	188	10000 / 22046	N	140 / 87
69	325/717	109	1030 / 2271	149	3250 / 7165	189	10300 / 22707	P	150 / 93
70	335/739	110	1060 / 2337	150	3350 / 7385	190	10600 / 23369	Q	160 / 99
71	345/761	111	1090 / 2403	151	3450 / 7606	191	10900 / 24030	R	170 / 106
72	355/783	112	1120 / 2469	152	3550 / 7826	192	11200 / 24691	S	180 / 112
73	365/805	113	1150 / 2535	153	3650 / 8047	193	11500 / 25353		
74	375/827	114	1180 / 2601	154	3750 / 8267	194	11800 / 26014		
75	387/853	115	1215 / 2679	155	3875 / 8543	195	12150 / 26786		
76	400/882	116	1250 / 2756	156	4000 / 8818	196	12500 / 27557		
77	412/908	117	1285 / 2833	157	4000 / 8818	197	12850 / 28329		
78	425/937	118	1320 / 2910	158	4250 / 9369	198	13200 / 29101		
79	437/964	119	1360 / 2998	159	4375 / 9645	199	13600 / 29982		
80	450/992	120	1400 / 3086	160	4500 / 9921	200	14000 / 30864		
81	462/1019	121	1450 / 3197	161	4625 / 10196	201	14500 / 31966		
82	475/1047	122	1500 / 3307	162	4750 / 10472	202	15000 / 33069		
83	487/1074	123	1550 / 3417	163	4875 / 10747	203	15500 / 34171		
84	500/1103	124	1600 / 3527	164	5000 / 11023	204	16000 / 35273		
85	515/1136	125	1650 / 3638	165	5150 / 11354	205	16500 / 36376		
86	530/1169	126	1700 / 3748	166	5300 / 11684	206	17000 / 37478		
87	545/1202	127	1750 / 3858	167	5450 / 12015	207	17500 / 38580		
88	560/1235	128	1800 / 3968	168	5600 / 12346	208	18000 / 39683		
89	580/1279	129	1850 / 4078	169	5800 / 12787	209	18500 / 40790		

5. Tyre Sidewall Markings

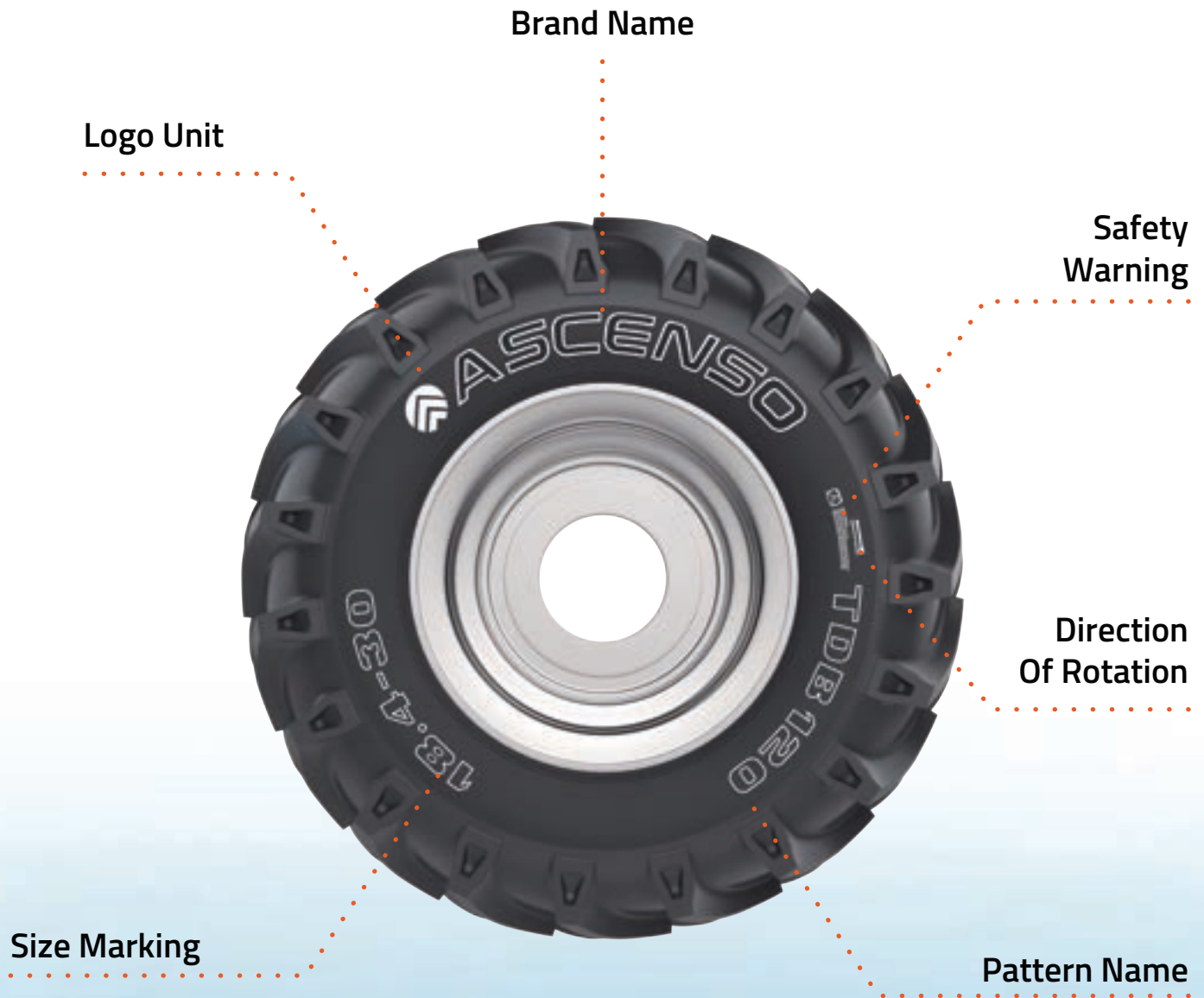

6. Product Nomenclature



Application	Category	Cat Code	Radial/ Bias	Design Number	Product Name
Agriculture	TRACTOR STEER	TS	B	110	TSB 110
	TRACTOR STEER	TS	B	111	TSB 111
	TRACTOR STEER	TS	B	112	TSB 112
	TRACTOR STEER	BOSS TS	B	10	BOSS TS 10
	TRACTOR DRIVE	TD	B	120	TDB 120
	TRACTOR DRIVE	TD	B	121	TDB 121
	TRACTOR DRIVE	TD	B	123	TDB 123
	TRACTOR DRIVE	TD	B	124	TDB 124
	TRACTOR DRIVE	BOSS TD	B	15	BOSS TD 15
	TRACTOR DRIVE	TD	R	850	TDR 850
	TRACTOR DRIVE	TD	R	700	TDR 700
	TRACTOR DRIVE	TD	R	800	TDR 800
	TRACTOR DRIVE	TD	R	650	TDR 650
	TRACTOR DRIVE	XL	R	880	XLR 880
	COMPACT DRIVE	CD	R	700	CDR 700
	ROW CROP	TD	R	900	TDR 900
	ROW CROP	VD	R	900	VDR 900
	ROW CROP	VD	R	901	VDR 901
	MULTI DRIVE	MD	R	1000	MDR 1000
	HARVESTER	HR	B	210	HRB 210
	HARVESTER	HR	R	200	HRR 200
	IMPLEMENT	IM	B	160	IMB 160
	IMPLEMENT	IM	B	161	IMB 161
	IMPLEMENT	IM	B	162	IMB 162
	IMPLEMENT	IM	B	163	IMB 163
	IMPLEMENT	IM	B	164	IMB 164
	IMPLEMENT	IM	B	165	IMB 165
	IMPLEMENT	BOSS TR	B	20	BOSS TR 20
	IMPLEMENT	BOSS TR	B	21	BOSS TR 21
	IMPLEMENT	IM	R	140	IMR 140
	IMPLEMENT	SP	R	250	SPR 250
	FLOTATION	FT	B	190	FTB 190
	FLOTATION	FT	R	170	FTR 170
IRRIGATION	IR	B	260	IRB 260	
TELEHANDLER	TH	B	230	THB 230	
TELEHANDLER	TH	B	230	THB 230 HD	
MULTI PURPOSE	SP	B	260	SPB 260	
MULTI PURPOSE	MP	R	390	MPR 390	
UTILITY TRACTOR	UT	R	240	UTR240	
Forestry	AGRO FORESTRY	AF	B	820	AFB 820
	AGRO FORESTRY	AF	B	821	AFB 821
	LOG SKIDDER	LS	B	780	LSB780
	FORESTRY FORWARDER	FF	B	840	FFB 840

7. Abbreviation

SR No.	Abbreviation	Fullform
1	(SH/SW)	(Section Height/Section Width)
2	PR	Ply rating
3	TRA	Tyre and Rim association
4	VF	Very-High Flexion
5	HD	Heavy Duty
6	SB	Steel Belted
7	SG	Stubble Guard
8	SL	Standard Load
9	DB	Dual Bead
10	CR	Cut Resistant
11	kg / lbs	kilogram/ Pound
12	kmph	kilometre per hour
13	mph	miles per hour
14	LI/SI	Load Index/Speed Index
15	2WD	2-wheel drive
16	4WD	4-wheel drive
17	OD	Overall Diameter
18	Psi	Pound per square inch
19	SLR	Static loaded Radius
20	FR	Free Rolling
21	DW	Drive Wheel
22	kPa	kilo Pascal
23	RC	Rolling Circumference
24	Cat Code	Category Code
25	TT	Tube Type
26	TL	Tube Less
27	Rec.	Recommended
28	Alt.	Alternate
29	V	Value Plus

● Agriculture



● Tractor





Wider Centre Rib:

Ease in steering and prevents damage to the grassland

High Strength Nylon Carcass:

Provides stability to the machine and ensures durability

Special Tread Compound:

- Provides longer tyre life
- Resistance to puncture



Size	Rim	Unloaded Dimensions		SLR	RC	LI/SI or PR	Inflation Pressure	Recommended load, kg (lbs)						
								Speed, km/h(mph)						
		SW	OD	Mixed Application										
		mm	mm	Static	10			20	25	30	40			
		in	in		in			in	in	in	in			
5.00-15	4.00E	130	664	308	1986	6PR 76A8	4.2	1200	800	550	510	440	400	
		5.1	26.1	12.1	78.2		60	2640	1760	1210	1120	970	880	
5.50-16	4.00E	150	713	330	2133	6PR 82A8	3.9	1430	950	650	610	530	475	
		5.9	28.1	13.0	84.0		56	3150	2090	1430	1340	1170	1050	
6.00-16	4.50E	159	739	341	2211	6PR 85A8	3.6	1550	1030	710	660	570	515	
		6.3	29.1	13.4	87.0		52	3410	2270	1560	1450	1260	1130	
6.00-16	4.50E	159	739	341	2211	8PR 91A8	4.7	1850	1230	850	790	680	615	
		6.3	29.1	13.4	87.0		68	4070	2710	1870	1740	1500	1350	
6.50-16	4.50E	173	761	350	2276	6PR 88A8	3.3	1680	1120	770	720	620	560	
		6.8	30.0	13.8	89.6		48	3700	2470	1700	1590	1370	1230	
7.50-16	5.50F	203	808	369	2417	8PR 99A8	3.9	2330	1550	1070	990	860	775	
		8.0	31.8	14.5	95.2		56	5130	3410	2360	2180	1890	1710	
7.50-16	5.50F	203	808	369	2417	10PR 104A8	4.8	2700	1800	1240	1150	1000	900	
		8.0	31.8	14.5	95.2		69	5950	3960	2730	2530	2200	1980	
9.00-16	W8L	234	856	389	2561	10PR 111A8	4.2	3270	2180	1500	1400	1210	1090	
		9.2	33.7	15.3	100.8		60	7200	4800	3300	3080	2670	2400	
10.00-16	W8L	274	894	405	2674	10PR 115A8	3.4	3650	2430	1680	1560	1350	1215	
		10.8	35.2	15.9	105.3		49	8040	5350	3700	3440	2970	2680	
11.00-16	W10L	315	967	435	2893	10PR 118A8	3.3	3960	2640	1820	1690	1470	1320	
		12.4	38.1	17.1	113.9		48	8720	5810	4010	3720	3240	2910	
7.50-18	5.50F	203	859	395	2570	8PR 102A8	3.9	2550	1700	1170	1090	940	850	
		8.0	33.8	15.6	101.2		56	5620	3740	2580	2400	2070	1870	
4.00-19	3.00D	112	717	338	2145	4PR 69A8	3.6	980	650	450	420	360	325	
		4.4	28.2	13.3	84.4		52	2160	1430	990	930	790	720	

TSB 110 - [F-2] [TT]



Tractor



Size	Rim	Unloaded Dimensions		SLR	RC	LI/SI or PR	Inflation Pressure	Recommended load, kg (lbs)						
		Speed, km/h(mph)												
		Mixed Application												
		Bar	Static					10	20	25	30	40		
		Psi						6	12	16	19	25		
6.00-19	4.50E	165	815	379	2438	6PR 89A8	3.6	1740	1160	800	740	640	580	
		6.5	32.1	14.9	96.0		52	3830	2560	1760	1630	1410	1280	
7.50-20	5.50E	203	909	420	2719	8PR 105A8	3.9	2780	1850	1280	1180	1030	925	
		8.0	35.8	16.5	107.0		56	6120	4070	2820	2600	2270	1040	



Unique Dumbbell Pattern:

Reduces block tearing and shoulder block deformation

Strong Nylon Carcass:

Provides stability to the machine and ensures durability

Special Tread Compound:

- Ensures longer tyre life
- Resistance to puncture



Size	Rim	Unloaded Dimensions		SLR	RC	LI/SI or PR	Inflation Pressure	Recommended load, kg (lbs)					
								Speed, km/h(mph)					
		SW	OD	Mixed Application									
		mm	mm	Bar	Static	10	20	25	30	40			
		in	in								Psi	6	12
4.50-16	3.00D	122	655	306	1959	6PR 74A8	4.5	1130	750	510	480	420	375
		4.8	25.8	12	77.1		65	2490	1650	1120	1060	930	830
5.00-16	4.00E	14.5	680	317	2034	6PR 76A8	4.2	1200	800	550	510	440	400
		5.7	26.8	12.5	80.1		61	2640	1760	1210	1120	970	880
5.50-16	4.00E	150	713	330	2133	6PR 82A8	3.9	1430	950	650	610	530	475
		5.9	28.1	13	84		56	3150	2090	1430	1340	1170	1050
6.00-16	4.50E	165	739	341	2211	8PR 91A8	4.5	1850	1230	850	790	680	615
		6.5	29.1	13	87		65	4070	2710	1870	1740	1500	1350
6.50-16	4.50E	175	760	356	2274	8PR 94A8	4.2	2010	1340	920	860	740	670
		6.9	29.9	14.0	89.5		61	4430	2950	2030	1890	1630	1480
7.50-16	5.50F	203	808	369	2417	8PR 99A8	3.9	1330	1550	1070	990	860	775
		7.9	31.8	14.5	95.2		56	5130	3410	2360	2180	1890	1710
7.50-18	5.50F	203	859	395	2570	8PR 102A8	3.9	2550	1700	1170	1090	940	850
		7.9	33.8	15.6	101.2		56	5620	3740	2580	2400	2070	1870
6.00-19	4.50E	165	814	376	2435	8PR 91A8	3.9	1850	1230	850	790	680	615
		6.5	32.0	14.8	95.9		56	4070	2710	1870	1740	1500	1350
6.50-20	4.50F	175	865	397	2588	8PR 98A8	3.9	2250	1500	1040	960	830	750
		6.9	34.1	15	101.9		56	4960	3300	2290	2110	1830	1650
7.50-20	5.50F	205	915	420	2719	8PR 105A8	3.9	2780	1850	1280	1180	1030	925
		8.1	36	16.5	107		56	6120	4070	2820	2600	2270	2040



Wider Ribs:

- Provides ease in steering
- Better manoeuvring

High Strength Nylon Carcass:

- Provides longer tyre life
- Trouble-free service



Size	Rim	Unloaded Dimensions		SLR	RC	LI/SI or PR	Inflation Pressure	Recommended load, kg (lbs)					
		SW	OD					Speed, km/h(mph)					
								Mixed Application					
								Static	15	25	30	40	
Bar	9	16	19	25									
mm	mm	mm	mm	mm	mm	Psi							
in	in	in	in	in	in								
9.5L-15 SL	7.00	251	782	356	2339	8PR 102A8	3.3	1700	1280	1090	940	850	
		9.88	30.79	14.02	92.09		48	3740	2820	2400	2070	1870	
11L-15 SL	8LB	279	813	369	2432	8PR 106A8	3	1900	1430	1220	1050	950	
		10.98	32.01	14.53	95.75		44	4190	3150	2690	2310	2090	
10.00-16 SL	8LB	274	894	404	2674	8PR 110A8	3	2120	1590	1360	1180	1060	
		10.79	35.20	15.91	105.28		44	4670	3500	3000	2600	2330	
11.00-16 SL	10LB	315	967	434	2892	8PR 114A8	2.8	2360	1770	1510	1310	1180	
		12.40	38.07	17.09	113.86		41	5200	3900	3330	2890	2600	



Specially-designed CCR Compound:

- Puncture and cut resistance
- Extra mileage

Wider Centre Rib:

Optimum road contact for better steering control



Tyre Size	PR	TT/TL	Load Index/ Speed Symbol	Rim	Unloaded Inflation Dimension				Static Loaded Radius		Rolling Circumference		Speed		Load-carrying Capacity			
					SW		OD								Max Load		Inflation Pressure	
					mm	in	mm	in	mm	in	mm	in	kg	lbs	bar	psi		
6.00-16	8	TT	94A6	4.50E	165	6.5	732	28.8	338	13.3	2189	86.2	30	19	670	1470	4.5	65
6.50-16	8	TT	98A6	4.50E	175	6.9	761	30.0	349	13.8	2276	89.6	30	19	750	1650	4.2	61
7.50-16	8	TT	103A6	5.50F	205	8.1	805	31.7	368	14.5	2408	94.8	30	19	875	1930	3.7	54



Wider Lugs:

Easy to penetrate the soil, generate optimum traction and ensure comfortable ride

Sturdy Sidewall Structure:

Provides resistance to external damage

Strong Nylon Carcass:

Safeguards the tyre against failures



Size	Rec. Rim	Alt. Rim	Unloaded Dimensions		SLR	RC	LI/SI or PR	Inflation Pressure	Recommended load, kg (lbs)							
									Field Operation			Speed, km/h(mph)				
			SW	OD	High Torque	Low Torque			Road Operation; Not high and sustained Torque							
			mm	mm		10			10	20	Static	10	20	30	40	
			in	in	Bar	6			6	12		6	12	19	25	
8.00-16	6LB	6L,6.00F	211	790	362	2363	6PR 88A8	1.9	600	840	690	1290	840	690	600	560
			8.3	31.1	14.2	93		28	1320	1850	1520	2840	1850	1520	1320	1230
8.3-20	W6	-	211	893	413	2671	6PR 92A8	2.4	670	950	770	1450	950	770	670	630
			8.3	35.2	16.3	105.2		34.8	1480	2090	1700	3190	2090	1700	1480	1390
9.5-20	W7	-	241	945	435	2827	6PR 99A8	2.1	830	1160	950	1780	1160	950	830	775
			9.5	37.2	17.1	111.3		30.45	1830	2560	2090	3920	2560	2090	1830	1710
11.2-20 (SB SG)	W10	-	284	1002	458	2997	8PR 107A8	2.4	1040	1460	1200	2240	1460	1200	1040	975
			11.1	39.4	18	117.9		35	2290	3220	2640	4930	3220	2630	2290	2150
8.3-24	W7	-	211	993	463	2970	8PR 105A8	3.1	990	1390	1140	2130	1390	1140	990	925
			8.3	39.1	18.2	116.9		45.0	2180	3060	2510	4690	3060	2510	2180	2040
9.5-24	W8	W8H, W7	241	1048	486	3135	8PR 112A8	2.8	1200	1680	1380	2580	1680	1380	1200	1120
			9.5	41.3	19.1	123.4		40.6	2640	3700	3040	5680	3700	3040	2640	2470
9.5-24	W8	W8H, W7	241	1048	486	3135	12PR 116A8	4	1340	1880	1540	2880	1880	1540	1340	1250
			9.5	41.3	19.1	123.4		58	2950	4140	3390	6340	4140	3390	2950	2750
11.2-24*	W10	W10H, W9	284	1103	509	3299	8PR 116A8	2.5	1340	1880	1540	2880	1880	1540	1340	1250
			11.2	43.4	20.0	129.9		36.3	2950	4140	3390	6340	4140	3390	2950	2750
11.2-24	W10	W10H, W9	284	1103	509	3299	12PR 124A8	3.6	1710	2400	1970	3680	2400	1970	1710	1600
			11.2	43.4	20.0	129.9		52	3770	5290	4340	8110	5290	4340	3770	3520
12.4-24	W11	W10H, W10	315	1159	532	3467	8PR 121A8	2.2	1550	2180	1780	3340	2180	1780	1550	1450
			12.4	45.6	20.9	136.5		31.9	3410	4800	3920	7360	4800	3920	3410	3190
12.4-24	W11	W10H, W10	315	1159	532	3467	12PR 128A8	3.4	1930	2700	2210	4140	2700	2210	1930	1800
			12.4	45.6	20.9	136.5		49	4250	5950	4870	9120	5950	4870	4250	3960
13.6-24	W12	W11	345	1210	553	3619	8PR 123A8	1.9	1660	2330	1910	3570	2330	1910	1660	1550
			13.6	47.6	21.8	142.5		27.6	3660	5130	4210	7860	5130	4210	3660	3410



Size	Rec. Rim	Alt. Rim	Unloaded Dimensions		SLR	RC	LI/SI or PR	Inflation Pressure	Recommended load, kg (lbs)								
			SW	OD					Field Operation			Speed, km/h(mph)					
									High Torque	Low Torque		Road Operation; Not high and sustained Torque					
			mm	mm					mm	10	10	20	Static	10	20	30	40
			in	in					in	in	in	in		6	6	12	6
13.6-24	W12	W11	345	1210	553	3619	12PR 130A8	2.9	2030	2850	2340	4370	2850	2340	2030	1900	
			13.6	47.6	21.8	142.5		42	4470	6280	5150	9630	6280	5150	4470	4190	
14.9-24	W13	-	378	1265	576	3784	8PR 128A8	1.8	1930	2700	2210	4140	2700	2210	1930	1800	
			14.9	49.8	22.7	149		26.1	4250	5950	4870	9120	5950	4870	4250	3960	
14.9-24	W13	-	378	1265	576	3784	12PR 136A8	2.6	2400	3360	2760	5150	3360	2760	2400	2240	
			14.9	49.8	22.7	149		37.7	5290	7400	6080	11340	7400	6080	5290	4930	
16.9-24	W15L	-	429	1333	604	3987	8PR 133A8	1.7	2200	3090	2530	4740	3090	2530	2200	2060	
			16.9	12.5	23.8	157		23.9	4850	6810	5570	10440	6810	5570	4850	4540	
16.9-24	W15L	-	429	1333	604	3987	12PR 143A8	2.4	2920	4090	3350	6270	4090	3350	2920	2725	
			16.9	12.5	23.8	157		34.8	6430	9010	7380	13810	9010	7380	6430	6000	
14.9-26	W12	DW12A	378	1316	601	3936	10PR 129A8	2.2	1980	2780	2280	4260	2780	2280	1980	1850	
			15	51.8	23.6	154.9		32	4360	6120	5020	9380	6120	5020	4360	4070	
14.9-26	W12	DW12A	378	1316	601	3936	12PR 134A8	2.7	2270	3180	2610	4880	3180	2610	2270	2120	
			15	51.8	23.6	154.9		39	5000	7000	5750	10750	7000	5750	5000	4670	
16.9-26	W15L	DW14A, DW15A	429	1384	629	4140	10PR 133A8	1.9	2200	3090	2530	4740	3090	2530	2200	2060	
			16.8	54.4	24.7	162.9		28	4850	6810	5579	10440	6810	5570	4850	4540	
11.2-28	W10	-	284	1205	560	3604	8PR 118A8	2.5	1410	1980	1620	3040	1980	1620	1410	1320	
			11.2	47.4	22	141.9		36.3	3110	4360	3570	6700	4360	3570	3110	2910	
12.4-28	W11L	W10H	315	1260	582	3769	8PR 123A8	2.2	1660	2330	1910	3570	2330	1910	1660	1550	
			12.4	49.6	22.9	148.4		31.9	3660	5130	4210	7860	5130	4210	3660	3410	
12.4-28	W11L	W10H	315	1260	582	3769	12PR 131A8	3.5	2090	2930	2400	4490	2930	2400	2090	1950	
			12.4	49.6	22.9	148.4		51	4600	6450	5290	9890	6450	5290	4600	4300	
13.6-28	W12	-	345	1311	604	3921	8PR 125A8	1.9	1770	2480	2030	3800	2480	2030	1770	1650	
			13.6	51.6	23.8	154.4		27.6	3900	5460	4470	8370	5460	4470	3900	3630	
14.9-28	W13	W12	378	1367	627	4089	8PR 130A8	1.8	2030	2850	2340	4370	2850	2340	2030	1900	
			14.9	53.8	24.7	161		26.1	4470	6280	5150	9630	6280	5150	4470	4190	
14.9-28	W13	W12	378	1367	627	4089	12PR 137A8	2.6	2460	3450	2830	5290	3450	2830	2460	2300	
			14.9	53.8	24.7	161		38	5420	7600	6230	11650	7600	6230	5420	5070	
16.9-28	W15L	-	429	1435	655	4292	8PR 135A8	1.7	2330	3270	2680	5010	3270	2680	2330	2180	
			16.9	56.5	25.8	169		23.9	5130	7200	5900	11040	7200	5900	5130	4800	
16.9-28	W15L	-	429	1435	655	4292	12PR 143A8	2.4	2920	4090	3350	6270	4090	3350	2920	2725	
			16.9	56.5	25.8	169		34.8	6430	9010	7380	13810	9010	7380	6430	6000	
7.2-30	W6	-	183	1095	519	3275	6PR 96A8	2.8	760	1070	870	1630	1070	870	760	710	
			7.2	43.1	20.4	128.9		41	1670	2360	1920	3590	2360	1920	1670	1560	
9.5-30	W7	W8	241	1200	562	3589	6PR 111A8	2.8	1170	1640	1340	2510	1640	1340	1170	1090	
			9.4	47.2	22.1	141.2		41	2580	3610	2950	5530	3610	2950	2580	2400	



Size	Rec. Rim	Alt. Rim	Unloaded Dimensions		SLR	RC	LI/SI or PR	Inflation Pressure	Recommended load, kg (lbs)								
			SW	OD					Field Operation			Speed, km/h(mph)					
									High Torque	Low Torque		Road Operation; Not high and sustained Torque					
			mm	mm					mm	10	10	20	Static	10	20	30	40
			in	in					in	6	6	12		6	12	19	25
14.9-30	W13	DW13A	378	1418	652	4241	8PR 127A8	1.8	1870	2630	2150	4030	2630	2150	1870	1750	
			14.8	55.8	25.6	166.9		26	4120	5790	4740	8880	5790	4740	4120	3850	
16.9-30	W15L	W14L, DW14	429	1485	680	4442	8PR 137A8	1.65	2460	3450	2830	5290	3450	2830	2460	2300	
			16.9	58.5	26.8	174.9		23.9	5420	7600	6230	11650	7600	6230	5420	5070	
16.9-30	W15L	-	429	1485	680	4442	12PR 144A8	2.5	3000	4200	3440	6440	4200	3440	3000	2800	
			16.9	58.5	26.8	174.9		36	6610	9250	7580	14190	9250	7580	6610	6170	
16.9-30	W15L	W14L, DW14	429	1485	680	4442	14PR 146A8	2.8	3210	4500	3690	6900	4500	3690	3210	3000	
			16.9	58.5	26.8	174.9		41	7070	9910	8130	15200	9910	8130	7070	6610	
18.4-30	W16L	-	467	1552	707	4642	8PR 139A8	1.4	2600	3650	2990	5590	3650	2990	2600	2430	
			18.4	61.1	27.8	182.8		20.3	5730	8040	6590	12310	8040	6590	5730	5350	
18.4-30	W16L	-	467	1552	707	4642	14PR 152A8	2.7	3800	5330	4370	8170	5330	4370	3800	3550	
			18.4	61.1	27.8	182.8		39	8370	11740	9630	18000	11740	9630	8370	7820	
18.4-30	W16L	DW16, W15L	467	1552	707	4642	16PR 154A8	2.9	4010	5630	4610	8630	5630	4610	4010	3750	
			18.4	61.1	27.8	182.8		42	8830	12400	10150	19010	12400	10150	8830	8260	
8.3-32	W7	-	211	1195	565	3574	8PR 111A6 107A8	3.2	1170	1530	1310	2510	1530	1310	1090	975	
			8.3	47	22.2	140.7		46.4	2580	3370	2890	5530	3370	2890	2400	2150	
9.5-32	W7	W8	241	1251	587	3741	6PR 106A8	2.1	1020	1430	1170	2190	1430	1170	1020	950	
			9.4	49.2	23.5	147.2		30	2250	3150	2580	4820	3150	2580	2250	2090	
12.4-32	W11L	-	315	1362	633	4074	8PR 125A8	2.2	1770	2480	2030	3800	2480	2030	1770	1650	
			12.4	53.6	24.9	160.4		31.9	3900	5460	4470	8370	5460	4470	3900	3630	
16.9-34	W15L	-	429	1587	731	4747	8PR 139A8	1.7	2600	3650	2990	5590	3650	2990	2600	2430	
			16.9	62.5	28.8	186.9		23.9	5730	8040	6590	12310	8040	6590	5730	5350	
18.4-34	W16L	-	467	1654	758	4947	8PR 142A8	1.4	2840	3980	3260	6100	3980	3260	2840	2650	
			18.4	65.1	29.8	194.8		20.3	6260	8770	7180	13440	8770	7180	6260	5840	
18.4-34	W16L	-	467	1654	758	4947	14PR 153A8	2.5	3910	5480	4490	8400	5480	4490	3910	3650	
			18.4	65.1	29.8	194.8		36.25	8610	12070	9890	18500	12070	9890	8610	8040	
12.4-36	W11L	W10H, W10	315	1464	684	4379	8PR 126A8	2.2	1820	2550	2090	3910	2550	2090	1820	1700	
			12.4	57.6	26.9	172.4		31.9	4010	5620	4600	8610	5620	4600	4010	3740	
12.4-36	W11L	W10H, W10	315	1464	684	4379	14PR 139A8	4	2600	3650	2990	5590	3650	2990	2600	2430	
			12.4	57.6	26.9	172.4		58	5730	8040	6590	12310	8040	6590	5730	5350	
13.6-36	W12	W11	345	1514	705	4529	8PR 129A8	1.9	1980	2780	2280	4260	2780	2280	1980	1850	
			13.6	59.6	27.8	178.3		27.6	4360	6120	5020	9380	6120	5020	4360	4070	
13.6-36	W12	W11	345	1514	705	4529	12PR 138A8	3.2	2530	3540	2900	5430	3540	2900	2530	2360	
			13.6	59.6	27.8	178.3		46	5570	7800	6390	11960	7800	6390	5570	5200	
13.6-36	W12	W11	345	1514	705	4529	14PR 142A8	3.5	2840	3980	3260	6100	3980	3260	2840	2650	
			13.6	59.6	27.8	178.3		51	6260	8770	7180	13440	8770	7180	6260	5840	



Size	Rec. Rim	Alt. Rim	Unloaded Dimensions		SLR	RC	LI/SI or PR	Inflation Pressure	Recommended load, kg (lbs)							
			SW	OD					Field Operation			Speed, km/h(mph)				
									High Torque	Low Torque		Road Operation; Not high and sustained Torque				
			mm	mm					mm	10	10	20	Static	10	20	30
in	in	in	in	in	in	Bar	10	10	20	6	12	19		25		
13.6-38	W12	W11	345	1565	730	4681	8PR 131A8	2	2090	2930	2400	4490	2930	2400	2090	1950
			13.6	61.6	28.7	184.3		29	4600	6450	5290	9890	6450	5290	4600	4300
13.6-38	W12	W11	345	1565	730	4681	10PR 136A8	2.5	2400	3360	2760	5150	3360	2760	2400	2240
			13.6	61.6	28.7	184.3		36	5290	7400	6080	11340	7400	6080	5290	4930
13.6-38	W12	W11	345	1565	730	4681	14PR 138A8	3.5	2530	3540	2900	5430	3540	2900	2530	2360
			13.6	61.6	28.7	184.3		51	5570	7800	6390	11960	7800	6390	5570	5200
15.5-38	W14L	DW14A	394	1569	732	4712	8PR 133A8	1.8	2200	3090	2530	4740	3090	2530	2200	2060
			15.5	61.8	28.8	185.5		26.1	4850	6810	5570	10440	6810	5570	4850	4540
15.5-38	W14L	DW14A	394	1569	732	4712	10PR 138A6	2.3	2530	3300	2830	5430	3300	2830	2360	2120
			15.5	61.8	28.8	185.5		33	5570	7270	6230	11960	7270	6230	5200	4670
15.5-38	W14L	DW14A	394	1569	732	4712	12PR 141A6	2.8	2760	3610	3090	5920	3610	3090	2575	2320
			15.5	61.8	28.8	185.5		41	6080	7950	6810	13040	7950	6810	5670	5110
16.9-38	W15L	-	429	1689	782	5052	8PR 141A8	1.7	2760	3860	3170	5920	3860	3170	2760	2575
			16.9	66.5	30.8	198.9		23.9	6080	8500	6980	13040	8500	6980	6080	5670
16.9-38	W15L	W14L, DW14, W15A	429	1689	782	5052	14PR 151A8	2.6	3690	5180	4240	7940	5180	4240	3690	3450
			16.9	66.5	30.8	198.9		38	8130	11410	9340	17490	11410	9340	8130	7600
18.4-38*	W16L	-	467	1755	809	5249	8PR 143A8	1.4	2920	4090	3350	6270	4090	3350	2920	2725
			18.5	69.1	32	206.7		20.3	6430	9010	7380	13810	9010	7380	6430	6000
18.4-38	W16L	W16A, W15L	467	1755	809	5249	14PR 155A8	2.6	4150	5810	4770	8910	5810	4770	4150	3875
			18.4	69.1	31.9	206.7		38	9140	12800	10510	19630	12800	10510	9140	8540

Note: The size marked in star is TT/TL



- Optimised lug distribution to support excellent traction and self-cleaning for puddling operation
- Better inner volume to give higher traction in wet & moist soil conditions
- Good lateral traction gives operational stability



Size	Rim	Unloaded Dimensions		SLR	RC	LI/SI or PR	Inflation Pressure	Recommended load, kg (lbs)					
		SW	OD					Speed, km/h(mph)					
		mm	mm					10	15	20	25	30	40
		in	in					6	9	12	16	19	25
5-12	4JA	127	528	244	1579	6PR 64A6 60A8	3.5	390	360	340	300	280	250
		5	20.8	10	62		51	860	790	750	660	620	550
6-12	5JA	155	577	265	1726	6PR 71A6 67A8	2.6	480	450	410	370	345	310
		6.1	22.7	10	68		38	1060	990	900	810	760	680
6-14*	5JA	155	627	290	1875	4PR 66A6 63A8	1.9	420	390	360	320	300	270
		6.1	24.7	11	74		28	920	860	790	700	660	590
9.5-18	W8	241	900.0	411	2692	8PR 105A6 101A8	3	1300	1200	1110	990	925	830
		9.5	35.4	16.2	106		44	2860	2640	2440	2180	2040	1830
8.3-20	W7	211	892	412	2668	8PR 101A6 98A8	3.2	1160	1070	990	880	825	740
		8.3	35.1	16	105		46	2550	2350	2180	1940	1820	1630
9.5-20	W8	241	955	438	2856	8PR 107A6 103A8	2.8	1370	1270	1170	1040	975	880
		9.5	37.6	17.2	112.4		41	3010	2790	2570	2290	2150	1940
9.5-24	W8	241	1050	486	3140	8PR 111A6 108A8	2.8	1530	1420	1310	1170	1090	980
		9.5	41.3	19	124		41	3370	3120	2880	2570	2400	2160
12.4-24	W11	315	1160	532	3469	8PR 120A6 117A8	2.3	1960	1820	1680	1500	1400	1260
		12.4	45.7	20.9	136.6		33	4310	4000	3700	3300	3080	2770
13.6-26	W12	345	1260	578	3768	8PR 126A6 123A8	2.2	2380	2210	2040	1820	1700	1530
		13.6	49.6	22.8	148.3		32	5240	4860	4490	4000	3740	3370
12.4-28	W11	315	1260	582	3768	12PR 131A6 127A8	3.5	2730	2540	2340	2090	1950	1760
		12.4	49.6	22.9	148.3		51	6010	5590	5150	4600	4290	3870
13.6-28	W12	345	1310	603	3918	12PR 134A6 130A8	3	2970	2760	2540	2270	2120	1910
		13.6	51.6	23.7	154.2		44	6530	6070	5590	4990	4660	4200
14.9-28	W13	378	1370	627	4097	12PR 137A6 133A8	2.6	3220	2990	2760	2460	2300	2070
		14.9	53.9	25	161		38	7080	6580	6070	5410	5060	4550
16.9-28	W15L	435	1440	656	4307	12PR 143A6 139A8	2.4	3820	3540	3270	2920	2725	2450
		17.1	56.7	25.8	169.6		35	8400	7790	7190	6420	6000	5390

Note: The size marked in star is TL



Unique 23° Lug Design:

- Excellent ground contact
- Unbeatable traction

Strong Nylon Carcass:

Safeguards the tyre against failures

Special Tread Compound:

Ensures longer tyre life



Size	Rim	Unloaded Dimensions		SLR	RC	LI/SI or PR	Inflation Pressure	Recommended load, kg (lbs)							
		SW	OD					Field Operation			Speed, km/h(mph)				
								High Torque	Low Torque		Road Operation; Not high and sustained Torque				
		mm	mm					mm	mm	Bar	10	10	20	Static	10
in	in	in	in	Psi	6	6	12	6	12	19	25				
23.1-26	DW20	587	1605	720	4801	12PR 153A8	1.7	3910	5480	4490	8400	5480	4490	3910	3650
		23.1	63.2	28.3	189.0		25	8620	12080	9900	18510	12080	9900	8620	8040
23.1-26**	DW20	587	1605	720	4801	16PR 159A8	2.3	4680	6560	5380	10060	6560	5380	4680	4375
		23.1	63.2	28.3	189.0		33	10310	14460	11860	22170	14460	11860	10310	9640
20.8-38*	W18A	528	1834	841	5486	8PR 148A8	1.3	3370	4730	3870	7250	4730	3870	3370	3150
		20.8	72.2	33.1	216.0		19	7430	10420	8530	15980	10420	8530	7430	6940
20.8-38*	W18A	528	1834	841	5486	14PR 159A8	2.3	4680	6560	5380	10060	6560	5380	4680	4375
		20.8	72.2	33.1	216.0		33	10310	14460	11860	22170	14460	11860	10310	9640

Note: (1) The size marked in star is TT. (2) The size marked in double star is TT/TL



Specially Designed to Maximise the Load Capacity:

- Ensure self-cleaning
- Extensive footprint area for uniform load distribution
- Better lateral stability on the field



Size	Rec. Rim	Alt. Rim	Unloaded Dimensions		SLR	RC	LI/SI or PR	Inflation Pressure	Recommended load, kg (lbs)				
			SW	OD					Speed, km/h(mph)				
									Tractor application				
									Bar	Static	10	20	25
			Psi	6							12	16	19
24.5-32	DW21B	DW20B	622	1803	815	5392	12PR 159A6	1.7	10060	6130	5250	4680	4375
			24.5	71.0	32.09	212.3		25	22160	13500	11560	10310	9640



Unique Mud Breaker:

Excellent self-cleaning properties during field operation

Dual-angle Lug Design:

Provides unbeatable traction

High Non-skid Depth:

Best-in-class mileage



Tyre Size	PR	TT/TL	Load Index/ Speed Symbol	Rim	Unloaded Inflation Dimension				Static Loaded Radius		Rolling Circumference		Speed		Load-carrying Capacity			
					SW		OD								Max Load		Inflation Pressure	
					mm	in	mm	in	mm	in	mm	in	kmph	mph	kg	lbs	bar	psi
12.4-28	12	TT	125A6	W11	315	12.4	1260	49.6	582	22.9	3768	148.4	30	19	1650	3630	2.5	36
13.6-28	12	TT	128A6	W12	345	13.6	1310	51.6	603	23.7	3918	154.2	30	19	1800	3960	2.3	33
14.9-28	12	TT	134A6	W13	378	14.9	1365	53.7	625	24.6	4082	160.7	30	19	2120	4670	2.3	33
16.9-28	12	TT	143A6	W15L	429	16.9	1435	56.5	654	25.8	4292	169.0	30	19	2725	6000	2.4	35
*18.4-30	14	TT	152A8	W16L	467	18.4	1552	61.1	707	27.8	4642	182.8	40	25	3550	7820	2.7	39

Note: Star marked size is also for Harvester Machinery.



Optimum Tread Design:

Maximum performance in the field and on-road operations

First in the Industry with Dual Mud Breakers:

Ensure better self-cleaning and maximum traction

Greater Lug Overlap:

Provides safe and comfortable ride at high speeds



Size	Rim	Unloaded Dimensions		SLR	RC	LI/SI or PR	Inflation Pressure	Recommended load, kg (lbs)							
								Speed, km/h(mph)							
		SW	OD	Mixed application											
		mm	mm	mm	mm			Bar	Static	10	25	30	40	50	65
		in	in	in	in			Psi		6	16	19	25	31	40
600/65R28	DW20B	611	1491	677	4459	154D	2.4	8630	5630	4440	4310	4110	3940	3750	
		24.1	58.7	26.7	175.6		35	19010	12400	9780	9490	9050	8680	8260	
600/70R28	DW20B	611	1551	702	4639	161D	2.8	10640	6940	5480	5320	5060	4860	4625	
		24.1	61.1	27.6	182.6		41	23440	15290	12070	11720	11150	10700	10190	
600/70R30	DW20B	611	1602	728	4791	152D	2.4	8170	5330	4210	4080	3890	3730	3550	
		24.1	63.1	28.7	188.6		35	18000	11740	9270	8990	8570	8220	7820	
600/70R34	DW20B	611	1704	778	5098	160D	2.4	10350	6750	5330	5180	4930	4730	4500	
		24.1	67.1	30.6	200.7		35	22800	14870	11740	11410	10860	10420	9910	
650/75R38	DW21B	655	1941	885	5805	169D	2.4	13340	8700	6870	6670	6350	6090	5800	
		25.8	76.4	34.8	228.5		35	29380	19160	15130	14690	13990	13410	12780	
650/85R38	DW23B	675	2071	939	6194	173D	2.4	14950	9750	7700	7480	7120	6830	6500	
		26.6	81.5	37.0	243.9		35	32930	21480	16960	16480	15680	15040	14320	
710/70R38	DW23B	716	1959	893	5859	172D	2.4	14490	9450	7470	7250	6900	6620	6300	
		28.2	77.1	35.2	230.7		35	31920	20810	16450	15970	15200	14580	13880	
710/70R38	DW23B	716	1959	893	5859	178D	3.4	17250	11250	8890	8630	8210	7880	7500	
		28.2	77.1	35.2	230.7		49	38000	24780	19580	19010	18080	17360	16520	
800/70R38	DW25B	798	2085	945	6236	178D	2.4	17250	11250	8890	8630	8210	7880	7500	
		31.4	82.1	37.2	245.5		35	38000	24780	19580	19010	18080	17360	16520	
620/70R42	DW20B	625	1935	892	5787	166D	2.4	12190	7950	6280	6100	5800	5570	5300	
		24.6	76.2	35.1	227.8		35	26850	17510	13830	13440	12780	12270	11670	
710/70R42	DW23B	716	2061	944	6164	173D	2.4	14950	9750	7700	7480	7120	6830	6500	
		28.2	81.1	37.2	242.7		35	32930	21480	16960	16480	15680	15040	14320	
710/75R42	DW23B	706	2133	973	6379	175D	2.4	15870	10350	8180	7940	7560	7250	6900	
		27.8	84	38.3	251.1		35	34960	22800	18020	17490	16650	15970	15200	



Size	Rim	Unloaded Dimensions		SLR	RC	LI/SI or PR	Inflation Pressure	Recommended load, kg (lbs)						
		Speed, km/h(mph)												
		Mixed application												
		Bar	Static					10	25	30	40	50	65	
		Psi						6	16	19	25	31	40	
mm	mm	mm	mm	mm	mm	mm	mm							
in	in	in	in	in	in	in	in							
600/65R28	DW20B	611	1491	677	4459	154D	2.4	8630	5630	4440	4310	4110	3940	3750
		24.1	58.7	26.7	175.6		35	19010	12400	9780	9490	9050	8680	8260
600/70R28	DW20B	611	1551	702	4639	161D	2.8	10640	6940	5480	5320	5060	4860	4625
		24.1	61.1	27.6	182.6		41	23440	15290	12070	11720	11150	10700	10190
600/70R30	DW20B	611	1602	728	4791	152D	2.4	8170	5330	4210	4080	3890	3730	3550
		24.1	63.1	28.7	188.6		35	18000	11740	9270	8990	8570	8220	7820
600/70R34	DW20B	611	1704	778	5098	160D	2.4	10350	6750	5330	5180	4930	4730	4500
		24.1	67.1	30.6	200.7		35	22800	14870	11740	11410	10860	10420	9910
650/85R38 (SB SG)	DW23B	675	2071	939	6194	173D	2.4	14950	9750	7700	7480	7120	6830	6500
		26.6	81.5	37.0	243.9		35	32930	21480	16960	16480	15680	15040	14320
710/70R38	DW23B	716	1959	893	5859	172D	2.4	14490	9450	7470	7250	6900	6620	6300
		28.2	77.1	35.2	230.7		35	31920	20810	16450	15970	15200	14580	13880
710/70R38	DW23B	716	1959	893	5859	178D	3.4	17250	11250	8890	8630	8210	7880	7500
		28.2	77.1	35.2	230.7		49	38000	24780	19580	19010	18080	17360	16520
800/70R38	DW25B	798	2085	945	6236	178D	2.4	17250	11250	8890	8630	8210	7880	7500
		31.4	82.1	37.2	245.5		35	38000	24780	19580	19010	18080	17360	16520
620/70R42	DW20B	625	1935	892	5787	166D	2.4	12190	7950	6280	6100	5800	5570	5300
		24.6	76.2	35.1	227.8		35	26850	17510	13830	13440	12780	12270	11670
710/70R42 SB & SG	DW23B	716	2061	944	6164	173D	2.4	14950	9750	7700	7480	7120	6830	6500
		28.2	81.1	37.2	242.7		35	32930	21480	16960	16480	15680	15040	14320
710/75R42	DW23B	706	2133	973	6379	175D	2.4	15870	10350	8180	7940	7560	7250	6900
		27.8	84	38.3	251.1		35	34960	22800	18020	17490	16650	15970	15200

Note: SB-Steel Belted SG-Stubble Guard



Optimum Tread Design:

Maximum performance in the field and on-road operations

First in the Industry with Dual Mud Breakers:

Ensure better self-cleaning

Greater Lug Overlap:

Provides safe and comfortable ride at high speeds



Size	Rim	Unloaded Dimensions		SLR	RC	LI/SI or PR	Inflation Pressure	Recommended load, kg (lbs)									
		SW	OD					Speed, km/h(mph)									
								Mixed application									
		mm	mm					mm	mm	Bar	Static	10	25	30	40	50	65
		in	in					in	in	Psi		6	16	19	25	31	40
420/65R20	W13	418	1054	479	3165	135D	2.4	5010	3270	2580	2510	2390	2290	2180			
		16.5	41.5	18.9	124.6		35	11040	7200	5680	5530	5260	5040	4800			
440/65R20	W14L	441	1080	490	3243	138D	2.4	5430	3540	2800	2710	2580	2480	2360			
		17.4	42.5	19.3	127.7		35	11960	7800	6170	5970	5680	5460	5200			
440/65R24	W14L	441	1182	541	3535	135D	2.4	5010	3270	2580	2510	2390	2290	2180			
		17.4	46.5	21.3	139.2		35	11040	7200	5680	5530	5260	5040	4800			
480/65R24	W15L	479	1234	563	3691	140D	2.4	5750	3750	2960	2880	2740	2630	2500			
		18.8	48.5	22.1	145.3		35	12670	8260	6520	6340	6040	5790	5510			
540/65R24	W16L	530	1312	595	3924	146D	2.4	6900	4500	3560	3450	3290	3150	3000			
		20.8	51.6	23.4	154.5		35	15200	9910	7840	7600	7250	6940	6610			
440/65R28	W14L	441	1283	591	3837	138D	2.4	5430	3540	2800	2710	2580	2480	2360			
		17.4	50.5	23.3	151.1		35	11960	7800	6170	5970	5680	5460	5200			
480/65R28	W15L	479	1335	613	3993	142D	2.4	6100	3980	3140	3050	2900	2780	2650			
		18.8	52.5	24.1	157.2		35	13440	8770	6920	6720	6390	6120	5840			
540/65R28	W16L	530	1413	646	4226	149D	2.4	7480	4880	3850	3740	3560	3410	3250			
		20.8	55.6	25.4	166.4		35	16480	10750	8480	8240	7840	7510	7160			
540/65R30	W16L	530	1464	671	4479	150D	2.4	7710	5030	3970	3850	3670	3520	3350			
		20.8	57.6	26.4	176.3		35	16980	11080	8740	8480	8080	7750	7380			
540/65R34	W16L	530	1566	722	4684	152D	2.4	8170	5330	4210	4080	3890	3730	3550			
		20.8	61.6	28.4	184.4		35	18000	11740	9270	8990	8570	8220	7820			
600/65R34	DW20B	611	1644	754	4917	157D	2.4	9490	6190	4890	4740	4520	4330	4125			
		24	64.7	29.6	193.5		35	20900	13630	10770	10440	9960	9540	9090			
540/65R38	W16L	530	1667	773	4986	153D	2.4	8400	5480	4330	4200	4000	3830	3650			
		20.8	65.6	30.4	196.3		35	18500	12070	9540	9250	8810	8440	8040			
600/65R38	DW20B	611	1745	805	5219	159D	2.4	10060	6560	5180	5030	4790	4590	4375			
		24	68.7	31.7	205.5		35	22160	14450	11410	11080	10550	10110	9640			

TDR 650 - [R-1W] [TL]



Tractor



Size	Rim	Unloaded Dimensions		SLR	RC	LI/SI or PR	Inflation Pressure	Recommended load, kg (lbs)						
		Speed, km/h(mph)												
		Mixed application												
		Bar	Static					10	25	30	40	50	65	
		Psi						6	16	19	25	31	40	
650/65R38	DW20B	645	1811	832	5438	163D	2.4	11210	7310	5780	5610	5340	5120	4875
		25.4	71.3	32.8	214.1		35	24690	16100	12730	12360	11760	11280	10740
650/65R38 (SB)	DW20B	645	1811	832	5438	171D	3.6	14150	9230	7290	7070	6730	6460	6150
		25.4	71.3	32.8	214.1		52	31170	20330	16060	15570	14820	14230	13550
650/65R42	DW20B	645	1913	883	5722	165D	2.4	11850	7730	6100	5920	5640	5410	5150
		25.4	75.3	34.7	225.3		35	26100	17030	13440	13040	12420	11920	11340

Note: SB- Steel Belted



Tractor Tyres Designed with a Unique Mud Breaker:

- Low soil compaction
- High traction
- Excellent driving experience



Size	Rim	Unloaded Dimensions		SLR	RC	LI/SI or PR	Inflation Pressure	Recommended load, kg (lbs)							
		SW	OD					Speed, km/h(mph)							
				Mixed application											
		mm	mm	mm	mm			Bar	Static	10	25	30	40	50	65
		in	in	in	in			Psi		6	16	19	25	31	40
360/70R20	W11	357	1042	474	3116	129D	2.4	4260	2780	2190	2130	2030	1940	1850	
		14.06	41.02	18.66	122.68		35	9380	6120	4820	4690	4470	4270	4070	
380/70R20	W12	380	1082	491	3236	122D	1.6	3450	2250	1780	1730	1640	1580	1500	
		15.0	42.6	19.3	127.4		23	7600	4960	3920	3810	3610	3480	3300	
320/70R24	W10	319	1094	505	3272	116D	1.6	2880	1880	1480	1440	1370	1310	1250	
		12.6	43.1	19.9	128.8		23	6340	4140	3260	3170	3020	2890	2750	
360/70R24	W11	357	1152	529	3446	122D	1.6	3450	2250	1780	1730	1640	1580	1500	
		14.1	45.4	20.8	135.7		23	7600	4960	3920	3810	3610	3480	3300	
380/70R24	W12	380	1190	545	3560	125D	1.6	3800	2480	1960	1900	1810	1730	1650	
		15.0	46.9	21.5	140.2		23	8370	5460	4320	4190	3990	3810	3630	
420/70R24 (SB SG)	W13	418	1248	569	3733	130D	1.6	4370	2850	2250	2190	2080	2000	1900	
		16.5	49.1	22.4	147.0		23	9630	6280	4960	4820	4580	4410	4190	
480/70R24	W15	479	1316	597	3936	138D	1.6	5430	3450	2800	2710	2580	2480	2360	
		18.9	51.8	23.5	155.0		23	11960	7800	6170	5970	5680	5460	5200	
360/70R28	W11	357	1251	579	3742	125D	1.6	3800	2480	1960	1900	1810	1730	1650	
		14.1	49.3	22.8	147.3		23	8370	5460	4320	4190	3990	3810	3630	
380/70R28	W12	380	1293	596	3868	127D	1.6	4030	2630	2070	1840	1750	1680	1600	
		15.0	50.9	23.5	152.3		23	8880	5790	4560	4430	4230	4050	3850	
420/70R28	W13	418	1349	619	4035	133D	1.6	4740	3090	2440	2370	2260	2160	1750	
		16.5	53.1	24.4	158.9		23	10440	6810	5370	5220	4980	4760	4540	
480/70R28	W15	479	1421	649	4250	140D	1.6	5750	3750	2960	2880	2740	2630	2500	
		18.9	55.9	25.6	167.3		23	12670	8260	6520	6340	6040	5790	5510	
480/70R30	W13	418	1398	644	4182	134D	1.6	4880	3180	2510	2440	2320	2230	2120	
		16.5	55.0	25.4	164.6		23	10750	7000	5530	5370	5110	4910	4670	
480/70R30	W15	479	1478	677	4221	141D	1.6	5920	3860	3050	2960	2820	2700	2575	
		18.9	58.2	26.7	166.2		23	13040	8500	6720	6520	6210	5950	5670	

TDR 700 - [R-1W] [TL]



Tractor



Size	Rim	Unloaded Dimensions		SLR	RC	LI/SI or PR	Inflation Pressure	Recommended load, kg (lbs)							
								Speed, km/h(mph)							
		SW	OD	Mixed application											
		mm	mm	mm	mm			Bar	Static	10	25	30	40	50	65
		in	in	in	in			Psi		6	16	19	25	31	40
480/70R34	W15	479	1580	728	4745	143D	1.6	6270	4090	3230	3130	2980	2860	2725	
		18.9	62.2	28.7	186.8		23	13810	9010	7010	6890	6560	6300	6000	
480/70R34 (SB), (SG)	W15	479	1580	728	4745	157D	3.6	9490	6190	4890	4740	4520	4330	4125	
		18.9	62.2	28.7	186.8		52	20900	13630	10770	10440	9960	9540	9090	
520/70R34	W16	516	1640	753	4905	148D	1.6	7250	4730	3730	3620	3450	3310	3150	
		20.3	64.6	29.6	193.1		23	15970	10420	8220	7970	7600	72900	6940	
480/70R38	W15	479	1681	778	5028	145D	1.6	6670	4350	3440	3340	3180	3050	2900	
		18.9	66.2	30.6	198.0		23	14690	9580	7580	7360	7000	6720	6390	
520/70R38	W16	577	1749	806	5231	150D	1.6	7710	5030	3970	3850	3670	3520	3350	
		20.3	68.9	31.7	205.9		23	16980	11080	8740	8480	8080	7750	7380	
580/70R38	DW18 L	577	1827	839	5465	155D	1.6	8910	5810	4590	4460	4240	4070	3875	
		22.7	71.9	33.0	215.2		23	19630	12800	10110	9820	9340	8960	8540	
580/70R38 (SB)	DW18 L	577	1827	839	5465	180D	5.5	18400	12000	9480	9200	8760	8400	8000	
		22.7	71.9	33.0	215.2		80	40530	26430	20880	20260	19300	18500	17620	

Note: SB- Steel Belt, SG- Stubble Guard



Tractor Tyres Designed with a Unique Mud Breaker:

- Low soil compaction
- High traction
- Excellent driving experience



Size	Rim	Unloaded Dimensions		SLR	RC	LI/SI or PR	Inflation Pressure	Recommended load, kg (lbs)							
								Speed, km/h(mph)							
		SW	OD	Mixed application											
		mm	mm	10	25			30	40	50	65				
		in	in	6	16			19	25	31	40				
380/80R38	W12	385	1575	734	4730	142D	2.4	6100	3980	3140	3050	2900	2780	2650	
		15.2	62	28.9	186.2		35	13440	8770	6920	6720	6390	6120	5840	
380/80R38 (SB), (SG)	W12	385	1575	734	4730	152D	4	8170	5330	4210	4080	3890	3730	3550	
		15.2	62.0	28.9	186.2		58	18000	11740	9270	8990	8570	8220	7820	
480/80R42	DW16L	489	1842	853	5509	156D	1.6	7940	5180	4090	3970	3780	3620	3450	
		19.3	72.5	33.6	216.9		23	17490	11410	9010	8740	8330	7970	7600	
480/80R46	DW16L	489	1944	904	5814	158D	2.4	9780	6380	5040	4890	4650	4460	4250	
		19.3	76.5	35.6	228.9		35	21540	14050	11100	10770	10240	9820	9360	
480/80R50	DW16L	489	2046	955	6119	159D	2.4	10060	6560	5180	5030	4790	4590	4375	
		19.3	80.6	35.6	240.9		35	22160	14450	11410	11080	10550	10110	9640	
480/80R50	DW16L	489	2046	955	6119	165D	3.2	11850	7730	6100	5920	5640	5410	5150	
		19.3	80.6	35.6	240.9		46	26100	17030	13440	13040	12420	11920	11340	

Note: SB- Steel Belt, SG- Stubble Guard



Tractor Tyres Designed with a Unique Mud Breaker:

- Low soil compaction
- High traction
- Excellent driving experience



Size	Rim	Unloaded Dimensions		SLR	RC	LI/SI or PR	Inflation Pressure	Recommended load, kg (lbs)							
		SW	OD					Speed, km/h(mph)							
		Mixed application													
		mm	mm					mm	mm	Bar	Static	10	25	30	40
in	in	in	in	Psi		6	16	19	25	31	40				
250/85R20	W8	251	934	430	2805	116D	2.4	2880	1880	1480	1440	1370	1310	1250	
		9.9	36.8	16.9	110.4		35	6340	4140	3260	3170	3020	2890	2750	
280/85R20	W10	292	984	450	2943	116D	1.9	2880	1880	1480	1440	1370	1310	1250	
		11.5	38.7	17.7	115.9		28	6340	4140	3260	3170	3020	2890	2750	
320/85R20	W11	329	1052	478	3146	119D	1.6	3130	2040	1610	1560	1490	1430	1360	
		12.95	41.42	18.82	123.86		23	6890	4490	3550	3440	3280	3150	3000	
250/85R24	W8	251	1036	481	3098	109D	1.6	2370	1550	1220	1180	1130	1080	1030	
		9.9	40.8	18.9	122.9		23	5220	3410	2690	2600	2490	2380	2270	
280/85R24	W10	282	1086	502	3248	115D	1.6	2790	1820	1440	1400	1330	1280	1215	
		11.1	42.8	19.8	127.9		23.2	6150	4010	3170	3080	2930	2820	2680	
320/85R24	W11	319	1154	530	3452	122D	1.6	3450	2250	1780	1730	1640	1580	1500	
		12.6	45.4	20.9	135.9		23.2	7600	4960	3920	3810	3610	3480	3300	
340/85R24	W12	360	1188	544	3554	125D	1.6	3800	2480	1960	1900	1810	1730	1650	
		14.2	46.8	21.4	139.9		23.2	8370	5460	4320	4190	3990	3810	3630	
380/85R24	W12	399	1256	572	3757	131D	1.6	4490	2930	2310	2240	2140	2050	1950	
		15.7	49.4	22.5	147.9		23.2	9890	6450	5090	4930	4710	4520	4300	
420/85R24	W15L	439	1324	600	3960	137D	1.6	5290	3450	2730	2650	2520	2420	2300	
		17.3	52.1	23.6	155.9		23.2	11650	7600	6010	5840	5550	5330	5070	
280/85R28	W10	282	1187	552	3551	118D	1.6	3040	1980	1560	1520	1450	1390	1320	
		11.1	46.7	21.7	139.8		23.2	6700	4360	3440	3350	3190	3060	2910	
320/85R28	W11	319	1255	580	3754	124D	1.6	3680	2400	1900	1840	1750	1680	1600	
		12.6	49.4	22.8	147.8		23.2	8110	5290	4190	4050	3850	3700	3520	
340/85R28	W12	360	1289	594	3856	127D	1.6	4030	2630	2070	2010	1920	1840	1750	
		14.2	50.7	23.4	151.8		23.2	8880	5790	4560	4430	4230	4050	3850	
380/85R28	W12	399	1357	622	4059	133D	1.6	4740	3090	2440	2370	2260	2160	2060	
		15.7	53.4	24.5	159.8		23.2	10440	6810	5370	5220	4980	4760	4540	

TDR 850 - [R-1W] [TL]



Tractor



Size	Rim	Unloaded Dimensions		SLR	RC	LI/SI or PR	Inflation Pressure	Recommended load, kg (lbs)							
		SW	OD					Speed, km/h(mph)							
				Mixed application											
		mm	mm	mm	mm			Bar	Static	10	25	30	40	50	65
		in	in	in	in			Psi		6	16	19	25	31	40
420/85R28	W15L	439	1425	651	4262	139D	1.6	5590	3650	2880	2790	2660	2550	2430	
		17.3	56.1	25.6	167.8		23.2	12310	8040	6340	6150	5860	5620	5350	
420/85R30	W15L	439	1476	676	4415	140D	1.6	5750	3750	2960	2880	2740	2630	2500	
		17.3	58.1	26.6	173.8		23.2	12670	8260	6520	6340	6040	5790	5510	
380/85R30	W12	380	1408	647	4211	135D	1.6	5010	3270	2580	2510	2390	2290	2180	
		15.0	55.4	25.5	165.8		23.2	11040	7200	5680	5530	5260	5040	4800	
460/85R30	W16L	478	1544	704	4618	145D	1.6	6670	4350	3440	3340	3180	3050	2900	
		18.8	60.8	27.7	181.8		23.2	14690	9580	7580	7360	7000	6720	6390	
320/85R32	W11	319	1357	631	4059	126D	1.6	3910	2550	2010	1960	1860	1790	1700	
		12.6	53.4	24.8	159.8		23.2	8610	5620	4430	4320	4100	3940	3740	
320/85R32 (SB)	W11	319	1357	631	4059	145D	4.4	6670	4350	3440	3340	3180	3050	2900	
		12.6	53.4	24.8	159.8		64	14690	9580	7580	7360	7000	6720	6390	
380/85R34	W12	380	1510	698	4516	137D	1.6	5290	3450	2730	2650	2520	2420	2300	
		15.0	59.4	27.5	177.8		23.2	11650	7600	6010	5840	5550	5330	5070	
420/85R34	W15L	438	1578	727	4739	142D	1.6	6100	3980	3140	3050	2900	2780	2650	
		17.2	62.1	28.6	186.6		23.2	13440	8770	6920	6720	6390	6120	5840	
420/85R34 (SB) (SG)	W15L	438	1578	727	4739	152D	3	8170	5330	4210	4080	3890	3730	3550	
		17.2	62.1	28.6	186.6		44	18000	11740	9270	8990	8570	8220	7820	
460/85R34	W16L	478	1646	755	4923	147D	1.6	7070	4610	3640	3540	3370	3230	3075	
		18.8	64.8	29.7	193.8		23.2	15570	10150	8020	7800	7420	7110	6770	
320/85R36	W11	319	1458	682	4361	128D	1.6	4140	2700	2130	2070	1970	1890	1800	
		12.6	57.4	26.9	171.7		23.2	9120	5950	4690	4560	4340	4160	3960	
320/85R36	W11	329	1458	682	4361	148D	4.6	7250	4730	3730	3620	3450	3310	3150	
		13.0	57.4	26.9	171.7		67	15970	10420	8220	7970	7600	7290	6940	
340/85R36	W12	360	1492	696	4463	132D	1.6	4600	3000	2370	2300	2190	2100	2000	
		14.2	58.7	27.4	175.7		23.2	10130	6610	5220	5070	4820	4630	4410	
320/85R38	W11	319	1509	707	4513	143D	3.6	6270	4090	3230	3130	2980	2860	2725	
		12.6	59.4	27.8	177.7		52	13810	9010	7110	6890	6560	6300	6000	
340/85R38	W12	343	1543	721	4615	133D	1.6	4740	3090	2440	2370	2260	2160	2060	
		13.5	60.7	28.4	181.7		23	10440	6810	5370	5220	4980	4760	4540	
420/85R38	W15L	439	1679	778	5022	144D	1.6	6440	4200	3320	3220	3070	2940	2800	
		17.3	66.1	30.6	197.7		23.2	14190	9250	7310	7090	6760	6480	6170	
460/85R38 (SB SG)	W16L	478	1747	806	5225	149D	1.6	7480	4880	3850	3740	3560	3410	3250	
		18.8	68.8	31.7	205.7		23.2	16480	10750	8480	8240	7840	7510	7160	
520/85R38	DW16L	542	1849	848	5530	155D	1.6	8910	5810	4590	4460	4240	4070	3875	
		21.3	72.8	33.4	217.7		23.2	19630	12800	10110	9820	9340	8960	8540	

Note: SB- Steel Belt, SG- Stubble Guard

TDR 850 - [R-1W] [TL]



Tractor



Size	Rim	Unloaded Dimensions		SLR	RC	LI/SI or PR	Inflation Pressure	Recommended load, kg (lbs)						
								Speed, km/h(mph)						
		SW	OD	Mixed application										
		mm	mm	mm	mm			mm	mm	mm	mm	mm	mm	mm
in	in	in	in	in	in	Bar	Static	10	25	30	40	50	65	
						Psi		6	16	19	25	31	40	
520/85R42	DW16L	542	1951	899	5836	157D	1.6	9490	6190	4890	4740	4520	4330	4125
		21.3	76.8	35.4	229.8		23.2	20900	13630	10770	10440	9960	9540	9090
520/85R42	DW16L	542	1951	899	5836	165D	2.8	11850	7730	6100	5920	5640	5410	5150
		21.3	76.8	35.4	229.8		41	26100	17030	13440	13040	12420	11920	11340
520/85R46	DW16L	542	2052	949	6138	158D	1.6	9780	6380	5040	4890	4650	4460	4250
		21.3	80.8	37.4	241.7		23.2	21540	14050	11100	10770	10240	9820	9360
520/85R46	DW16L	542	2052	949	6138	169D	3.2	13340	8700	6870	6670	6350	6090	5800
		21.3	80.8	37.4	241.7		46	29380	19160	15130	14690	13990	13410	12780



Multi-angle Tread Pattern:

- Distinctive shoulder design provides high traction
- Dual mud breaker ensures better self-cleaning properties

Handling & Comfort:

- Larger footprint ensures better stability on-field and on-road
- Safeguards comforts on all surfaces



Size	Rim	Unloaded Dimensions		SLR	RC	LI/SI or PR	Inflation Pressure	Recommended load, kg (lbs)						
								Speed, km/h(mph)						
		SW	OD	Mixed application										
		mm	mm	mm	mm			mm	mm	mm	mm	mm	mm	mm
		in	in	in	in			in	in	in	in	in	in	in
240/70R16	W8	244	742	342	2219	104D	2.4	2070	1350	1070	1040	990	950	900
		9.6	29.2	13.5	87.4		35	4560	2970	2360	2290	2180	2090	1980
260/70R16	W8	258	770	353	2303	109D	2.4	2370	1550	1220	1180	1130	1080	1030
		10.2	30.3	13.9	90.7		35	5220	3410	2690	2600	2490	2380	2270
280/70R16	W9	272	798	365	2387	112D	2.4	2580	1680	1330	1290	1230	1180	1120
		10.7	31.4	14.4	94		35	5680	3700	2930	2840	2710	2600	2470
280/70R18	W9	282	849	390	2539	114D	2.4	2710	1770	1400	1360	1290	1240	1180
		11.1	33.4	15.4	100		35	5970	3900	3080	3000	2840	2730	2600
340/65R18	W11	343	899	411	2689	113D	1.6	2650	1730	1360	1320	1260	1210	1150
		13.5	35.4	16.2	105.9		23	5840	3810	3000	2910	2780	2670	2530
260/70R20	W8	258	872	404	2608	113D	2.4	2650	1730	1360	1320	1260	1210	1150
		10.2	34.3	15.9	102.7		35	5840	3810	3000	2910	2780	2670	2530
300/70R20	W9	295	952	437	2847	120D	2.4	3220	2100	1660	1610	1530	1470	1400
		11.6	37.5	17.2	112.1		35	7090	4630	3660	3550	3370	3240	3080
280/70R20	W9	282	900	416	2692	116D	2.4	2880	1880	1480	1440	1370	1310	1250
		11.1	35.4	16.4	106		35	6340	4140	3260	3170	3020	2890	2750
320/70R20	W10	319	982	450	2937	123D	2.4	3570	2330	1840	1780	1700	1630	1550
		12.6	38.7	17.7	115.6		35	7860	5130	4050	3920	3740	3590	3410



Narrow & Sprayer Tyres Designed with a Unique Mud Breaker:

- High load-carrying capacity for smooth operations
- High traction
- Ensures soil protection and provides better roadability



Size	Rim	Unloaded Dimensions		SLR	RC	LI/SI or PR	Inflation Pressure	Recommended load, kg (lbs)							
								Speed, km/h(mph)							
		SW	OD	Mixed application											
		mm	mm	mm	mm			mm	mm	Static	10	25	30	40	50
		in	in	in	in			in	in		Bar	6	16	19	25
420/90R30	DW13	418	1518	693	4540	147A8/B	2.4	7070	4610	3410	3290	3075	3075		
		16.5	59.8	27.3	178.7		35	15570	10150	7510	7250	6770	6770		

Size	Rim	Unloaded Dimensions		SLR	RC	LI/SI or PR	Inflation Pressure	Recommended load, kg (lbs)								
								Speed, km/h(mph)								
		SW	OD	Mixed application												
		mm	mm	mm	mm			mm	mm	Static	10	25	30	40	50	65
		in	in	in	in			in	in		Bar	6	16	19	25	31
270/95R32	W9	275	1327	619	3969	136D	4	5150	3360	2650	2580	2450	2350	2240		
		10.8	52.2	24.4	156.3		58	11340	7400	5840	5680	5400	5180	4930		
230/95R32	W7	228	1251	587	3741	128D	4	4140	2700	2130	2070	1970	1890	1800		
		9.0	49.3	23.1	147.3		58	9120	5950	4690	4560	4340	4160	3960		
230/95R36	W7	228	1352	638	4044	130D	4	4370	2850	2250	2190	2080	2000	1900		
		9.0	53.2	25.1	159.2		58	9630	6280	4960	4820	4580	4410	4190		
270/95R36	W9	275	1428	669	4271	139D	4	5590	3650	2880	2790	2660	2550	2430		
		10.8	56.2	26.3	168.1		58	12310	8040	6340	6150	5860	5620	5350		
270/95R38	W9	275	1479	695	4423	140D	4	5750	3750	2960	2880	2740	2630	2500		
		10.8	58.2	27.4	174.1		58	12670	8260	6520	6340	6040	5790	5510		
380/95R38	W12	380	1687	780	5045	147D/ 150A8	2.4	7070	4610	3640	3540	3350	3230	3075		
		15.0	66.4	30.7	198.6		35	15570	10150	8020	7800	7380	7110	6770		
270/95R42	W9	275	1581	746	4728	139D	3.4	5590	3650	2880	2790	2660	2550	2430		
		10.8	62.2	29.4	186.1		49	12310	8040	6340	6150	5860	5620	5350		

Size	Rim	Unloaded Dimensions		SLR	RC	LI/SI or PR	Inflation Pressure	Recommended load, kg (lbs)							
		SW	OD					Speed, km/h(mph)							
		mm	mm	Mixed application											
		in	in	mm	mm			Bar	Static	10	25	30	40	50	65
		in	in	in	in			Psi		6	16	19	25	31	40
230/95R44	W7	228	1556	740	4654	134D	4	4880	3180	2510	2440	2320	2230	2120	
		9.0	61.3	29.1	183.2		58	10750	7000	5530	5370	5110	4910	4670	
270/95R44	W9	275	1632	771	4881	142D	4	6100	3980	3140	3050	2900	2780	2650	
		10.8	64.3	30.4	192.2		58	13440	8770	6920	6720	6390	6120	5840	
300/95R46	W9	295	1738	819	5198	148D	4	7250	4730	3730	3620	3450	3310	3150	
		11.6	68.4	32.2	204.6		58	15970	10420	8220	7970	7600	7290	6940	
320/90R46	W10	319	1744	822	5216	148D	3.6	7250	4730	3730	3620	3450	3310	3150	
		12.6	68.7	32.4	205.4		52	15970	10420	8220	7970	7600	7290	6940	
380/90R46 (SB)	W12	380	1852	866	5539	159D	4	10060	6560	5180	5030	4790	4590	4375	
		15.0	72.9	34.1	218.1		58	22160	14450	11410	11080	10550	10110	9640	
380/90R46 (SB)	W12	380	1852	866	5539	173D	6.1	14950	9750	7700	7480	7120	6830	6500	
		15.0	72.9	34.1	218.1		88	32930	21480	16960	16480	15680	15040	14320	
230/95R48	W7	228	1657	790	4956	136D	4	5150	3360	2650	2580	2450	2350	2240	
		9.0	65.2	31.1	195.1		58	11340	7400	5840	5680	5400	5180	4930	
270/95R48	W9	275	1733	822	5183	144D	4	6440	4200	3320	3220	3070	2940	2800	
		10.8	68.2	32.4	204.1		58	14190	9250	7310	7090	6760	6480	6170	
340/85R48	W12	353	1797	848	5374	151D	3.6	7940	5180	4090	3970	3780	3620	3450	
		13.9	70.7	33.4	211.6		52	17490	11410	9010	8740	8330	7970	7600	
320/90R50	W10	319	1846	873	5521	150D	3.6	7710	5030	3970	3850	3670	3520	3350	
		12.6	72.7	34.4	217.4		52	16980	11080	8740	8480	8080	7750	7380	
480/95R50	W15L	479	2182	1011	6526	164D/ 167A8	2.4	11500	7500	5930	5750	5450	5250	5000	
		18.9	85.9	39.8	256.9		35	25330	16520	13060	12670	12000	11560	11010	
300/95R52 (SB)	W9	295	1891	896	5656	156D	4.8	9200	6000	4740	4600	4380	4200	4000	
		11.6	74.4	35.3	222.7		70	20260	13220	10440	10130	9650	9250	8810	
270/95R54 (SB)	W9	275	1886	898	5641	156D	5.6	9200	6000	4740	4600	4380	4200	4000	
		10.8	74.3	35.4	222.1		81	20260	13220	10440	10130	9650	9250	8810	

Note: SB- Steel Belted



- Built to handle 40% more load than a conventional radial tyre, or the same load at 40% lower pressure.
- VF tyres with stronger lugs with larger Contact Patch gives Excellent traction with self-cleaning characteristics which decreases slippage , delivers lower fuel consumption, and increases overall productivity.
- Steel Belts offers Puncture Protection and distributes uniform ground pressure which helps less soil compaction and less crop damage.
- Reinforced sidewalls and bead zones offer increased casing stiffness to carry extra load.
- The more radially stiffer tyre makes it possible to transition from field to road and vice versa without adjusting the pressure. At the reduced pressure required for field use, the tyre can also run at full speed on the road yet deliver the same fuel efficiencies as a standard tyre at road pressure.



Size	Rim	Unloaded Dimensions		SLR	RC	LI/SI or PR	Inflation Pressure	Recommended load, kg (lbs)					
		SW	OD					Speed, km/h(mph)					
		mm	mm	mm	mm		Bar	10	25	30	40	50	65
		in	in	in	in		Psi	6	16	19	25	31	40
VF580/85R42 (SB)	DW20B	595	2040	935	6126	183D	2.8	9630	9010	8930	8750	8750	8750
		23.4	80.3	36.8	241.2		41	21210	19850	19670	19270	19270	19270
VF380/90R46 (SB)	W13	383	1852	866	5561	173D	4.4	7150	6700	6630	6500	6500	6500
		15.1	72.9	34.1	219		64	15750	14760	14600	14320	14320	14320
VF520/85R46 (SB)	DW18L	530	2052	949	6162	173D	2	7150	6700	6630	6500	6500	6500
		20.9	80.8	37.4	242.6		29	15750	14760	14600	14320	14320	14320
VF320/90R50 (SB)	W11	323	1846	873	5543	169D	4.8	6380	5970	5920	5800	5800	5800
		12.7	72.7	34.4	218.2		70	14050	13150	13040	12780	12780	12780
VF380/90R50 (SB)	W13	383	1954	917	5868	175D	4.4	7590	7110	7040	6900	6900	6900
		15.1	76.9	36.1	231		64	16720	15660	15510	15200	15200	15200
VF 420/95R50 SB	W14L	419	2068	964	6210	177 D	3.6	8030	7520	7450	7300	7300	7300
		16.5	81.4	38.0	244.5		52	17690	16560	16410	16080	16080	16080
VF480/80R50 (SB)	W11	479	2038	952	6120	179D	3.6	8530	7980	7910	7750	7750	7750
		18.9	80.2	37.5	240.9		52	18790	17580	17420	17070	17070	17070
VF 480/95R50 (SB)	DW16L	479	2182	1011	6552	176 D	2.4	7810	7310	7240	7100	7100	7100
		18.9	85.9	39.8	258.0		35	17200	16100	15950	15640	15640	15640

Note: SB- Steel Belted



Size	Rim	Unloaded Dimensions		SLR	RC	LI/SI or PR	Inflation Pressure	Recommended load, kg (lbs)					
		SW	OD					Speed, km/h(mph)					
		mm	mm					10	25	30	40	50	65
		in	in					6	16	19	25	31	40
VF320/90R54 (SB)	W11	323	1948	924	5850	168D	4.4	6160	5770	5710	5600	5600	5600
		12.7	76.7	36.4	230.3		64	13570	12710	12580	12330	12330	12330
VF380/105R54 (SB)	W13	383	2163	1012	6495	180 D	4.4	8800	8240	8160	8000	8000	8000
		15.1	85.2	39.9	255.7		64	19380	18150	17970	17620	17620	17620

Note: SB- Steel Belted



Directional Lug with Zig-Zig Blocks:

- Excellent traction which decreases slippage, delivers lower fuel consumption, and increases overall productivity
- Better Roadability

Advance VF Technology:

- Built to handle 40% more load than a conventional radial tyre, or the same load at 40% lower pressure

Reinforced Sidewalls and Bead Zones:

- Increased casing stiffness to carry extra load and easy of fitment

Extra Strong Casing with High Performance Steel Belts:

- Provides exceptional puncture resistance, with even footprint to disperse load equally.
- SB offers better impact resistance and defence against stubble to enhance tire durability



Size	Rim	Unloaded Dimensions		SLR	RC	LI/SI or PR	Inflation Pressure	Recommended load, kg (lbs)					
		SW	OD					Speed, km/h(mph)					
		mm	mm					10	25	30	40	50	65
		in	in					Bar	Psi	6	16	19	25
VF380/90R46 (SB)	W13	383	1852	866	5561	173D	4.4	7150	6700	6630	6500	6500	6500
		15.1	72.9	34.1	218.9		64	15750	14760	14600	14320	14320	14320

Note: SB- Steel Belted



Multi-block tread design with Wider footprint:

- Tread design gives wider footprint and gives excellent grip on/off road application even winter condition.
- Offset shoulder block design gives stable and comfortable driving response both ON/OFF road.

Unique Center Lug:

Provides Stability and a smooth, comfortable ride on hard surfaces, soft conditions even in mud and snow.

High number of blocks with high rubber-to-void ratio:

Provides low tire vibration and stable ride.

Extra Strong Casing Equipped with Steel Belts:

Higher load-carrying capacity in all applications & Improved Puncture resistance.

Special Tread Compound:

Longer Tire Life and provides even wear both on the road and in the field.



Size	Rim	Unloaded Dimensions		SLR	RC	LI/SI or PR	Inflation Pressure	Recommended load, kg (lbs)									
								Speed, km/h(mph)									
		SW	OD	Constant Load					Static								
		mm	mm	10	25	30	40	50					65	70	10	15	
in	in	in	in	in	in	in	in	in	in	in	in	in	in	in	in	in	
250/75R16 (SB)	W8	258	783	359	2342	120G	4.5		2520	2100	1750	1610	1570	1540	1500	1460	1400
		10.2	30.8	14.1	92.2		65		5550	4630	3850	3550	3460	3390	3300	3220	3080
340/80R18 (SB)	11	343	1001	453	2994	143A8/138D	4	6230	3410	2890	2830	2725	2480	2360	2150	4090	3650
		13.5	39.4	17.8	117.9		58	13720	7510	6370	6230	6000	5460	5200	4740	9010	8040
360/80R20 (SB)	11	357	1084	492	3242	147A8/143D	4	7190	3840	3260	3200	3075	2800	2725	2480	4610	4120
		14.1	42.7	19.4	127.6		58	15840	8460	7180	7050	6770	6170	6000	5460	10150	9070
360/80R24 (SB)	DW11	357	1186	543	3547	143A8/138D	3.2	6230	3410	2890	2830	2725	2480	2360	2150	4090	3650
		14.1	46.7	21.4	139.6		46	13720	7510	6370	6230	6000	5460	5200	4740	9010	8040
400/80R24 (14.9R24) (SB)	DW13	404	1250	569	3739	149A8/144D	3.2	7390	4060	3450	3380	3250	2960	2800	2550	4880	4360
		15.9	49.2	22.4	147.2		46	16280	8940	7600	7440	7160	6520	6170	5620	10750	9600
440/80R24 (16.9R24) (SB)	DW14L	441	1314	595	3930	154A8/149D	3.2	8580	4690	3980	3900	3750	3410	3250	2960	5630	5030
		17.4	51.7	23.4	154.7		46	18900	10330	8770	8590	8260	7510	7160	6520	12400	11080
400/80R28 (14.9R28) (SB)	DW13	404	1351	620	4041	151A8/146D	3.2	7920	4310	3660	3590	3450	3140	3000	2730	5180	4620
		15.9	53.2	24.4	159.1		46	17440	9490	8060	7910	7600	6920	6610	6010	11410	10180
440/80R28 (16.9R28) (SB)	DW14L	441	1415	646	4232	156A8/151D	3.2	9110	5000	4240	4160	4000	3640	3450	3140	6000	5360
		17.4	55.7	25.4	166.6		46	20070	11010	9340	9160	8810	8020	7600	6920	13220	11810
480/65R28 (SB)	DW15L	479	1335	613	3993	154A8/149D	3.2	8580	4690	3980	3900	3750	3410	3250	2960	5630	5030
		18.9	52.6	24.1	157.2		46	18900	10330	8770	8590	8260	7510	7160	6520	12400	11080
540/65R28 (SB)	W18L	540	1413	645	4226	160A8/155D	3.2	10230	5630	4770	4680	4500	4100	3875	3530	6750	6030
		21.3	55.6	25.4	166.4		46	22530	12400	10510	10310	9910	9030	8540	7780	14870	13280

MDR 1000 - [IND] [TL]



Tractor
Telehandler



Size	Rim	Unloaded Dimensions		SLR	RC	LI/SI or PR	Inflation Pressure	Recommended load, kg (lbs)									
								Speed, km/h(mph)									
		SW	OD	Bar	Psi	Static	Constant Load					Cyclic Applications					
		mm	mm				10	25	30	40	50	65	70	10	15		
in	in	in	in	in	in	in	in	in	in	in	in	in	in	in	in		
440/80R30 (16.9R30) (SB)	DW14L	441	1466	671	4385	157A8/ 153D	3.2	9640	5160	4370	4290	4125	3750	3650	3320	6190	5530
		17.4	57.7	26.4	172.6		46	21230	11370	9630	9450	9090	8260	8040	7310	13630	12180
480/80R30 (SB)	DW15L	479	1530	698	4576	162A8/ 157D	3.2	10890	5940	5040	4940	4750	4320	4125	3750	7130	6370
		18.9	60.2	27.5	180.2		46	23990	13080	11100	10880	10460	9520	9090	8260	15700	14030
540/65R30 (SB)	W18L	550	1464	671	4379	161A8/ 156D	3.2	10560	5780	4900	4810	4625	4210	4000	3640	6940	6200
		21.7	57.6	26.4	172.4		46	23260	12730	10790	10590	10190	9270	8810	8020	15290	13660
600/70R30 (SB)	DW20	611	1602	728	4791	171A8/ 166D	3.2	13990	7690	6520	6400	6150	5600	5300	4820	9230	8240
		24.1	63.1	28.7	188.6		46	30810	16940	14360	14100	13550	12330	11670	10620	20330	18150
440/80R34 (16.9R34) (SB)	DW14L	441	1568	722	4690	159A8/ 155D	3.2	10230	5470	4640	4550	4375	3980	3875	3530	6560	5860
		17.4	61.7	28.4	184.6		46	22530	12050	10220	10020	9640	8770	8540	7780	14450	12910
480/80R34 (18.4R34) (SB)	DW15L	479	1632	749	4881	164A8/ 159D	3.2	11550	6250	5300	5200	5000	4550	4375	3980	7500	6700
		18.9	64.3	29.5	192.2		46	25440	13770	11670	11450	11010	10020	9640	8770	16520	14760
480/80R38 (18.4R38) (SB)	DW15L	479	1733	800	5183	166A8/ 161D	3.2	12210	6630	5620	5510	5300	4820	4625	4210	7950	7100
		18.9	68.2	31.5	204.1		46	26890	14600	12380	12140	11670	10620	10190	9270	17510	15640
540/80R38 (20.8R38) (SB)	DW16L	530	1829	839	5470	172A8/ 167D	3.2	14390	7880	6680	6550	6300	5730	5450	4960	9450	8440
		20.9	72.0	33.0	215.4		46	31700	17360	14710	14430	13880	12620	12000	10930	20810	18590
600/65R38 (SB)	DW18L	591	1745	804	5219	170A8/ 166D	3.2	13990	7500	6360	6240	6000	5460	5300	4820	9000	8040
		23.3	68.7	31.7	205.5		46	30810	16520	14010	13740	13220	12030	11670	10620	19820	17710
650/65R38 (SB)	DW20B	645	1811	831	5416	175A8/ 170D	3.2	15840	8630	7310	7180	6900	6280	6000	5460	10350	9250
		25.4	71.3	32.7	213.2		46	34890	19010	16100	15810	15200	13830	13220	12030	22800	20370
650/65R38 (SB) (SG)	DW20B	645	1811	831	5416	175A8/ 170D	3.2	15840	8630	7310	7180	6900	6280	6000	5460	10350	9250
		25.4	71.3	32.7	213.2		46	34890	19010	16100	15810	15200	13830	13220	12030	22800	20370
650/85R38 (SB)	DW23B	675	2071	939	6194	183A8/ 178D	3.2	19800	10940	9280	9100	8750	7960	7500	6830	13130	11730
		26.6	81.5	37.0	243.9		46	43610	24100	20440	20040	19270	17530	16520	15040	28920	25840
650/65R42 (SB)	DW20B	645	1913	882	5721	176A8/ 171D	3.2	16240	8880	7530	7380	7100	6460	6150	5600	10650	9510
		25.4	75.3	34.7	225.2		46	35770	19560	16590	16260	15640	14230	13550	12330	23460	20950
710/70R42 (SB)	DW23B	716	2061	944	6164	185A8/ 180D	3.2	21120	11560	9810	9620	9250	8420	8000	7280	13880	12400
		28.2	81.1	37.2	242.7		46	46520	25460	21610	21190	20370	18550	17620	16040	30570	27310

Note: SB- Steel Belted, SG- Stubble Guard

● Harvester





23° Angle Lug Design:

- Stubble resistant design
- Designed for high load-carrying applications

Wider Lugs:

- Provides optimum traction



Size	Rim	Unloaded Dimensions		SLR	RC	LI/SI or PR	Inflation Pressure	Recommended load, kg (lbs)					
		Speed, km/h (mph)											
		Mixed application											
		Bar	Static					10	20	25	30		
23.1-26	DW20B	587	1605	720	4800	16PR 159A6	2.3	10060	6130	5250	4680	4375	
		23.1	63.2	28.3	189.0		33	22160	13500	11560	10310	9640	
30.5L-32	DH27B	775	1845	832	5518	18PR 170A6	2.1	13800	8400	7200	6420	6000	
		30.5	72.6	32.8	217.2		30	30400	18500	15860	14140	13220	

HRR 200 - [R-1] [TL]



Harvester



- Pattern optimised for quiet running
- Optimised carcass for better operational stability, roadability and maneuvering
- Specially designed for high load-carrying capacity



Size	Rim	Unloaded Dimensions		SLR	RC	LI/SI or PR	Inflation Pressure	Recommended load, kg (lbs)							
								Speed, km/h (mph)							
		SW	OD	Harvester Application											
		mm	mm	10	15			25	30	40	10	10			
in	in	in	in	in	in	in	in	in							
620/75R26 (SB)	DW20B	625	1590	714	4755	167A8	3.2	8180	7300	6470	5830	5450	5830	-	
							46	18020	16080	14250	12840	12000	12840	-	
		4	-	-	-		-	-	-	9270					
		58	-	-	-		-	-	-	20420					
650/75R32 (SB)	DW21B	655	1789	809	5351	172A8	3.2	9450	8440	7480	6740	6300	6740	-	
							46	20810	18590	16480	14850	13880	14850	-	
		4	-	-	-		-	-	-	10710					
		58	-	-	-		-	-	-	23590					
800/65R32 (SB)	DW27B	818	1853	835	5542	181A8	3.6	12380	11060	9800	8830	8250	8830	-	
							52	27270	24360	21590	19450	18170	19450	-	
		5	-	-	-		-	-	-	14030					
		65	-	-	-		-	-	-	30900					

Note: SB- Steel Belted

HRR 200 - [R-1] [TL]



Harvester



Size	Rim	Unloaded Dimensions		SLR	RC	LI/SI or PR	Inflation Pressure	Recommended load, kg (lbs)							
								Speed, km/h (mph)							
		SW	OD					Harvester Application							
		mm	mm					10	15	25	30	40	65	10	10
in	in	in	in	in	in	in	in	in	in						
900/60R32 (SB)	DW28B	896	1893	852	5662	191D	4.4	16350	14610	12920	12540	11940	10900	12540	-
							64	36010	32180	28460	27620	26300	24010	27620	---
		6	-	-	-		-	-	-	-	-	18530			
		80	-	-	-		-	-	-	-	-	40810			

Note: SB- Steel Belted

● Implement





Optimum Implement Design:

Minimises soil compaction and protects the grassland

Strong Nylon Carcass:

Provides high load-carrying capacity



Size	Rim	Unloaded Dimensions		SLR	RC	PR	Free/ Drive Wheel	Inflation Pressure	Recommended load, kg (lbs)							
									Speed, km/h(mph)							
		SW	OD	Free Rolling					Drive Wheel							
		mm	mm	10	25	40	50		10	25	40	50				
in	in	in	in	in	in	in	in	in	in	in	in	in	in	in		
7.50-10	5.50 F	208	633	283	1893	12	111A8 ☹️	5	1530	1300	1090	980	1090	920	775	700
		8.2	24.9	11.2	74.5		99A8 ☺️	73	3370	2860	2400	2160	2400	2020	1710	1540
10.0/80-12	9	264	710	320	2123	10	121A8 ☹️	3.9	2030	1710	1450	1310	1440	1220	1030	930
		10.4	28.0	12.6	83.6		109A8 ☺️	57	4470	3760	3190	2880	3170	2680	2270	2050
10.0/75-15.3 (260/75-15.3)	9	264	760	348	2274	10	123A8 ☹️	3.9	2170	1840	1550	1400	1530	1300	1090	981
		10.4	29.9	13.7	89.5		111A8 ☺️	57	4774	4048	3410	3080	3366	2860	2398	2158
10.0/75-15.3 (260/75-15.3)	9	264	760	348	2274	14	130A8 ☹️	5.5	2660	2260	1900	1710	1850	1570	1320	1188
		10.4	29.9	13.7	89.5		118A8 ☺️	80	5852	4972	4180	3762	4070	3454	2904	2614
10.0/75-15.3 (260/70-15.3)	9	264	760	348	2274	18	135A8 ☹️	7.1	3050	2590	2180	1960	2100	1790	1500	1350
		10.4	29.9	13.7	89.5		122A8 ☺️	103	6710	5700	4800	4310	4620	3940	3300	2970
11.5/80-15.3	9	290	845	383	2528	10	131A8 ☹️	3.4	2730	2300	1950	1760	1900	1600	1360	1220
		11.4	33.3	15.1	99.5		119A8 ☺️	49	6010	5060	4290	3870	4180	3520	2990	2680
11.5/80-15.3	9	290	845	383	2528	14	139A8 ☹️	4.8	3400	2890	2430	2190	2380	2020	1700	1530
		11.4	33.3	15.1	99.5		126A8 ☺️	69	7480	6358	5346	4818	5236	4444	3740	3366
11.5/80-15.3	9	290	845	383	2528	16	141A8 ☹️	5.4	3610	3060	2575	2320	2520	2140	1800	1620
		11.4	33.3	15.1	99.5		128A8 ☺️	78	7942	6732	5665	5104	5544	4708	3960	3564
11.5/80-15.3	9	290	845	383	2528	18	144A8 ☹️	6.3	3920	3300	2800	2520	2800	2360	2000	1800
		11.4	33.3	15.1	99.5		132A8 ☺️	91	8620	7260	6160	5540	6160	5190	4400	3960
12.5/80-15.3 (300/80-15.3)	9	295	869	393	2600	14	142A8 ☹️	4.3	3710	3150	2650	2390	2590	2200	1850	1665
		11.6	34.2	15.5	102.4		129A8 ☺️	62	8162	6930	5830	5258	5698	4840	4070	3663
12.5/80-15.3 (300/80-15.3)	9	295	869	393	2600	18	151A8 ☹️	6.8	4830	4070	3450	3110	3400	2870	2430	2190
		11.6	34.2	15.5	102.4		139A8 ☺️	98	10630	8950	7590	6840	7480	6310	5350	4820
400/60-15.5	AG 13.00	404	874	395	2614	16	146A8 ☹️	4	4200	3570	3000	2700	2880	2450	2060	1850
		15.9	34.4	15.6	102.9		133A8 ☺️	58	9240	7850	6600	5940	6340	5390	4530	4070
15.0/55-17 (380/55-17)	13.00	380	850	388	2542	10	134A8 ☹️	2.7	2970	2520	2120	1910	2100	1790	1500	1350
		15.0	33.5	15.3	100.1		122A8 ☺️	39	6530	5540	4660	4200	4620	3940	3300	2970



Size	Rim	Unloaded Dimensions		SLR	RC	PR	Free/ Drive Wheel	Inflation Pressure	Recommended load, kg (lbs)							
		SW	OD						Speed, km/h(mph)							
		mm	mm	Free Rolling				Drive Wheel								
		in	in	10	25	40	50	10	25	40	50					
15.0/55-17 (380/55-17)	13.00	380	850	388	2542	14	141A8 →	3.8	3610	3060	2575	2320	2520	2140	1800	1620
		15.0	33.5	15.3	100.1		128A8 ↻	54	7940	6730	5670	5100	5540	4710	3960	3560
19.0/45-17	16.00	489	864	394	2584	14	144A8 →	3	3920	3330	2800	2520	2730	2320	1950	1760
		19.3	34.0	15.5	101.7		131A8 ↻	44	8620	7330	6160	5540	6010	5100	4290	3870
500/50-17	16.00	503	932	422	2788	14	149A8 →	2.8	4550	3870	3250	2930	3140	2670	2240	2020
		19.8	36.7	16.6	109.8		136A8 ↻	41	10010	8510	7150	6450	6910	5870	4930	4440
10.5/65-16	W9	274	755	347	2258	14	130A8 →	5.3	2660	2660	1900	1710	1850	1570	1320	1190
		10.8	29.7	13.7	88.9		118A8 ↻	77	5850	4970	4180	3760	4070	3450	2900	2620
13.0/75-16	11	336	900	407	2692	12	138A8	3.6	3300	2780	2360	2120	-	-	-	-
		13.2	35.4	16.0	106.0			52	7260	6120	5190	4660	-	-	-	-
10.5/80-18	W9	274	885	405	2647	14	138A8	5.2	3300	2780	2360	2120	-	-	-	-
		10.8	34.8	15.9	104.2			75	7260	6120	5190	4660	-	-	-	-
12.5/80-18	9 or 11	308/328	965	439	2887	16	148A8 →	4.9	4410	3750	3150	2840	3050	2590	2180	1962
		12.1/12.9	38.0	17.3	113.7		135A8 ↻	71	9702	8250	6930	6248	6710	5698	4796	4316
13.0/65-18	11	336	890	408	2662	16	144A8 →	4.9	3920	3330	2800	2520	2730	2320	1950	1755
		13.2	35.0	16.1	104.8		131A8 ↻	71	8624	7326	6160	5544	6006	5104	4290	3861
14.0/65-16	11	357	874	396	2614	14	142 A8 FR	4.0	3710	3130	2650	2390	2590	2200	1850	1670
		14.1	34.4	15.6	102.9		129 A8 DW	58	8160	6890	5830	5260	5700	4840	4070	3670
15.0/70-18	13	391	990	449	2961	16	151A8 →	4.3	4830	4110	3450	3110	3400	2890	2430	2187
		15.4	39.0	17.7	116.6		139A8 ↻	62	10626	9042	7590	6842	7480	6358	5346	4811



Wider Footprint:

Minimises soil compaction and protects the grassland

Optimum Height to Width Ratio:

Ensures stability

Strong Nylon Carcass:

Provides high load-carrying capacity



Size	Rim	Unloaded Dimensions		SLR	RC	PR	Free/ Drive Wheel	Inflation Pressure	Recommended load, kg (lbs)							
									Speed, km/h(mph)							
		SW	OD	Free Rolling				Drive Wheel								
		mm	mm	10	25	40	50	10	25	40	50					
		in	in	in	in		LI/SI	Bar	10	25	40	50	10	25	40	50
								Psi	6	16	25	31	6	16	25	31
260/70-15.3	9	268	753	345	2253	10	122A8 ↻ 110A8 ↻	3.2	2100	1790	1500	1350	1480	1260	1060	950
		10.6	29.6	13.6	88.7			46	4620	3938	3300	2970	3260	2770	2330	2100
260/70-15.3	9	268	753	345	2253	14	130A8 ↻ 118A8 ↻	5.5	2660	2260	1900	1710	1850	1570	1320	1188
		10.6	29.6	13.6	88.7			80	5852	4972	4180	3762	4070	3450	2900	2610
300/80-15.3	9	295	869	392	2599	14	139A8 ↻	3.7	3400	2890	2430	2190	-	-	-	-
		11.6	34.2	15.4	102.3			54	7480	6358	5346	4818	-	-	-	-
400/60-15.5	13	404	874	395	2614	14	145A8 ↻ 132A8 ↻	3.6	4060	3450	2900	2610	2800	2380	2000	1800
		15.9	34.4	15.6	102.9			52	8932	7590	6380	5742	6160	5240	4400	3960
400/60-15.5	13	404	874	395	2614	16	148A8 ↻ 135A8 ↻	4.2	4410	3750	3150	2840	3050	2590	2180	1960
		15.9	34.4	15.6	102.9			61	9702	8250	6930	6248	6710	5700	4800	4320
400/60-15.5	13	404	874	395	2614	18	149A8 ↻ 136A8 ↻	4.5	4550	3870	3250	2930	3140	2670	2240	2020
		15.9	34.4	15.6	102.9			65	10010	8510	7150	6450	6910	5870	4930	4440
340/55-16	11	343	780	358	2333	12	133A8 ↻ 121A8 ↻	3.2	2880	2450	2060	1850	2030	1730	1450	1305
		13.5	30.7	14.1	91.9			46	6340	5390	4530	4070	4470	3810	3190	2870
340/55-16	11	343	780	358	2333	18	140A8 ↻ 128A8 ↻	4.8	3500	2980	2500	2250	2520	2140	1800	1620
		13.5	30.7	14.1	91.9			70	7700	6560	5500	4950	5540	4710	3960	3560
380/55-17	13	380	850	389	2543	10	134A8 ↻ 122A8 ↻	2.6	2970	2520	2120	1910	2100	1790	1500	1350
		15	33.5	15.3	100.1			38	6530	5540	4660	4200	4620	3940	3300	2970
380/55-17	13	380	850	389	2543	14	141A8 ↻ 128A8 ↻	3.2	3610	3060	2575	2320	2520	2140	1800	1620
		15	33.5	15.3	100.1			46	7940	6730	5670	5100	5540	4710	3960	3560
380/55-17	13	380	850	389	2543	18	146A8 ↻ 134A8 ↻	4.6	4200	3570	3000	2700	2970	2520	2120	1908
		15	33.5	15.3	100.1			67	9240	7850	6600	5940	6530	5540	4660	4200
480/45-17	16	479	864	395	2585	14	146A8 ↻ 134A8 ↻	3.2	4200	3570	3000	2700	2970	2520	2120	1908
		18.9	34	15.6	101.8			46	9240	7850	6600	5940	6530	5540	4660	4200
480/45-17	16	479	864	395	2585	18	149A8 ↻ 136A8 ↻	3.5	4550	3870	3250	2930	3140	2670	2240	2020
		18.9	34	15.6	101.8			51	10010	8510	7150	6450	6910	5870	4930	4435



Size	Rim	Unloaded Dimensions		SLR	RC	PR	Free/ Drive Wheel	Inflation Pressure	Recommended load, kg (lbs)							
		SW	OD						Speed, km/h(mph)							
									Free Rolling				Drive Wheel			
		mm	mm						10	25	40	50	10	25	40	50
in	in	in	in	in	in	Bar	10	25	40	50	10	25	40	50		
							LI/SI	Psi	6	16	25	31	6	16	25	31
500/50-17	16	503	932	423	2788	10	143A8 ↻	2	3820	3240	2725	2450	2730	2320	1950	1755
		19.8	36.7	16.7	109.8		131A8 ↻	29	8400	7130	5995	5390	6010	5100	4290	3860
500/50-17	16	503	932	423	2788	14	149A8 ↻	2.8	4550	3870	3250	2930	3220	2740	2300	2070
		19.8	36.7	16.7	109.8		137A8 ↻	41	10010	8510	7150	6450	7080	6030	5060	4550
500/50-17	16	503	932	423	2788	18	154A8 ↻	4	5250	4460	3750	3380	3710	3150	2650	2385
		19.8	36.7	16.7	109.8		142A8 ↻	58	11550	9810	8250	7440	8160	6930	5830	5250
400/70-20	13	414.0	1072.0	487.0	3206	16	156A8 ↻	4	5600	4760	4000	3600	3920	3330	2800	2520
		16.2	42.2	19.1	126.2		144A8 ↻	58	12320	10470	8800	7920	8620	7330	6160	5540
500/55-20	16	503	1058	481	3165	10	150A8 ↻	2	4690	3990	3350	3020	3300	2810	2360	2124
		19.8	41.7	18.9	124.6		138A8 ↻	35	10320	7890	7370	6640	7260	6180	5190	4670
500/55-20	16	503	1058	481	3165	12	155A8 ↻	3.2	5430	4610	3875	3490	3820	3240	2725	2450
		19.8	41.7	18.9	124.6		143A8 ↻	46	11950	10140	8525	7680	8400	7130	5995	5400



Specially-designed Directional Tread Pattern:

Ensures excellent traction and self-cleaning properties

Superior Carcass Construction:

High load-carrying capacity and directional stability

Special Tread Compound:

Ensures longer tyre life



Size	Rim	Unloaded Dimensions		SLR	RC	PR	Free/ Drive Wheel	Inflation Pressure	Recommended load, kg (lbs)								
		SW	OD						Speed, km/h(mph)								
						Free Rolling				Drive Wheel							
		mm	mm	mm	mm	LI/SI	Bar		10	25	40	50	10	25	40	50	
in	in	in	in	Psi	6		16	25	31	6	16	25	31				
6.5/80-12*	5J	163	588	269	1759	6	93A8	⊕	3.6	910	770	650	590	630	540	450	410
		6.4	23.1	10.6	69.2		80A8		52	2002	1694	1430	1298	1386	1188	990	902
7.00-12	4.5	187	683	308	2043	6	95A8	⊕	2.5	970	820	690	620	680	580	487	440
		7.4	26.9	12.1	80.4		83A8		36	2134	1804	1518	1364	1496	1276	1071	968
5.00-15	3.50D	130	655	304	1959	6	88A8	⊕	3.5	780	670	560	500	540	460	387	350
		5.1	25.8	11.9	77.1		75A8		51	1716	1474	1232	1100	1188	1012	851	770
7.5L-15	6LB	210	765	349	2288	8	113A8	⊕	3.7	1610	1370	1150	1040	1120	950	800	720
		8.3	30.1	13.7	90.1		100A8		54	3540	3010	2530	2290	2460	2090	1760	1580
10.0/75-15.3	9	264	780	356	2333	10	123A8	⊕	3.9	2170	1840	1550	1400	1530	1300	1090	981
		10.4	30.7	14	91.9		111A8		57	4774	4048	3410	3080	3366	2860	2398	2158.2
10.0/75-15.3	9	264	780	356	2333	14	130A8	⊕	5.5	2660	2260	1900	1710	1850	1570	1320	1188
		10.4	30.7	14	91.9		118A8		79.8	5852	4972	4180	3762	4070	3454	2904	2613.6
10.0/75-15.3	9	264	780	356	2333	18	135A8	⊕	7.1	3050	2590	2180	1960	2170	1840	1550	1395
		10.4	30.7	14	91.9		128A8		102.95	6710	5698	4796	4312	4774	4048	3410	3069
11.5/80-15.3	9	290	867	392	2594	12	135A8	⊕	4.1	3050	2590	2180	1960	2170	1840	1550	1395
		11.4	34.1	15.4	102.1		123A8		59.45	6710	5698	4796	4312	4774	4048	3410	3069
11.5/80-15.3	9	290	867	392	2594	14	139A8	⊕	4.8	3400	2890	2430	2190	2380	2020	1700	1530
		11.4	34.1	15.4	102.1		126A8		68.9	7480	6358	5346	4818	5236	4444	3740	3366
6.00-16	4.00E	160	730	337	2183	8	103A8	⊕	4	1230	1040	875	790	860	730	615	550
		6.3	28.7	13.3	86		91A8		58	2706	2288	1925	1738	1892	1606	1353	1210
6.50-16*	4.5KA 4.5KB	175	760	349	2273	8	105A8	⊕	3.7	1300	1100	925	830	910	770	650	590
		6.9	29.9	13.7	89.5		93A8		54	2860	2420	2040	1830	2000	1690	1430	1300
7.5-16	5.50F	209	803	367	2402	8	112A8	⊕	3.2	1570	1330	1120	1010	1090	920	775	700
		8.2	31.6	14.4	94.6		99A8		46	3450	2930	2460	2220	2400	2020	1710	1540



Size	Rim	Unloaded Dimensions		SLR	RC	PR	Free/ Drive Wheel	Inflation Pressure	Recommended load, kg (lbs)									
		SW	OD						Speed, km/h(mph)									
									Free Rolling				Drive Wheel					
		mm	mm						mm	mm	LI/SI	Bar	10	25	40	50	10	25
in	in	in	in		Psi	6	16	25	31	6	16	25	31					
19.0/45-17	16	470	877	400	2623	10	138A8	2.25	3300	2810	2360	2120	2310	1960	1650	1485		
		18.5	34.5	15.7	103.3		125A8	32.6	7260	6182	5192	4664	5082	4312	3630	3267		
19.0/45-17	16	470	877	400	2623	16	146A8	3.2	4200	3570	3000	2700	2880	2450	2060	1850		
		18.5	34.5	15.7	103.3		133A8	46	9240	7854	6600	5940	6336	5390	4532	4070		
7.50-18*	5.50F	209	854	392	2554	8	114A8	3.1	1650	1400	1180	1060	1160	980	825	740		
		8.2	33.6	15.4	100.6		101A8	45	3630	3080	2600	2330	2550	2160	1820	1630		
10.5/80-18	W9	274	900	411	2692	10	131A8	3.7	2730	2320	1950	1760	1900	1620	1360	1220		
		10.8	35.4	16.2	106		119A8	54	6006	5104	4290	3872	4180	3564	2992	2684		
12.5/80-18	W9	308	980	444	2931	12	142A8	3.7	3710	3150	2650	2390	2590	2200	1850	1670		
		12.1	38.6	17.5	115.4		129A8	54	8162	6930	5830	5258	5698	4840	4070	3674		
7.50-20*	5.50F	209	904	417	2704	8	116A8	3.25	1750	1490	1250	1130	1230	1040	875	790		
		8.2	35.6	16.4	106.4		103A8	47	3850	3280	2750	2490	2710	2290	1930	1740		

Note: The size marked in star is TT



Specially Designed Ribbed Tyre:

Low rolling resistance

Wider Centre Rib:

Provides excellent manoeuvrability and long tyre life

Constant Tension Construction Minimises Crowning of the Tyre



Size	Rim	Unloaded Dimension		SLR	RC	LI/SI or PR	Inflation Pressure	Recommended load, kg (lbs)
		SW	OD					Speed, km/h (mph)
		mm	mm					50
		in	in					31
9.5L-14 SL	8.00	241	741	337	2217	8PR 111B	3	1090
		9.5	29.2	13.3	87.3		44	2400
6.70-15 SL	4.5KB	170	705	324	2108	6PR 97B	3	730
		6.7	27.8	12.8	83.0		44	1600
7.60-15 SL	6.00	193	734	337	2196	10PR 110B	4.3	1060
		7.6	28.9	13.3	86.5		62	2330
9.5L-15SL	7.00	241	767	350	2294	8PR 112B	3	1120
		9.5	30.2	13.8	90.3		44	2470
9.5L-15SL	7.00	241	767	350	2294	12PR 121B	4.4	1450
		9.5	30.2	13.8	90.3		64	3200
11L-15SL	8.00	279	777	354	2323	8PR 113B	2.5	1150
		11.0	30.6	13.9	91.5		36	2540
11L-15SL	8.00	279	777	354	2323	12PR 121B	3.6	1450
		11.0	30.6	13.9	91.5		52	3200
12.5L-15SL	10.00	318	823	373	2462	12PR 127B	3.6	1750
		12.5	32.4	14.7	96.9		52	3860
12.5L-16SL	10.00	318	848	386	2537	14PR 130B	3.9	1900
		12.5	33.4	15.2	99.9		56	4180
16.5L-16.1 -i1	14.00	419	1024	459	3063	12PR 138B	2.5	2360
		16.5	40.3	18.1	120.6		36	5200
21.5L-16.1 -i1	18.00	546	1130	502	3380	10PR 146B	1.9	3000
		21.5	44.5	19.8	133.1		28	6610



Specially Designed Rib Pattern:

- Ensures soil protection
- Suitable for both on-road and off-road applications
- Built for carrying high loads



Size	Rim	Unloaded Dimensions		SLR	RC	PR	Inflation Pressure	Recommended load, kg (lbs)			
		SW	OD					Speed, km/h(mph)			
		mm	mm					Free Rolling			
		in	in					10	25	30	40
200/60-14.5	AG 6.75	205	608	283	1818	10PR	5	1330	1130	1060	950
		8.07	23.94	11.14	71.57	106A8	73	2930	2490	2330	2090
200/60-14.5	AG 6.75	205	608	283	1818	14PR	7	1610	1370	1290	1150
		8.07	23.94	11.14	71.57	113A8	102	3540	3010	2840	2530
250/65-14.5*	AG 8.00	251	694	318	2076	12PR	4.7	1900	1620	1520	1360
		9.88	27.32	12.52	81.73	119A8	68	4180	3560	3340	2990

Note: The size marked in star is TL

IMB 165 - [IMP] [TL]



Backhoe Loader,
Trench Digging,
Tillage and
Orchard Harvesting



Optimal Tread Design:

- Excellent traction & self-cleaning
- High contact area for better stability and driving comfort

Superior Carcass:

- Ensures better load-carrying capacity



Size	Rec. Rim	Alt. Rim	Unloaded Dimensions		SLR	RC	LI/SI or PR	Inflation Pressure	Recommended load, kg (lbs)	
			SW	OD					Speed, km/h(mph)	
			mm	mm					Bar	30
			in	in					Psi	19
23x8.50-12	7JA, 7.00-I-55; I-70; I-90	-	205	575	264	1720	6PR 89A6	2.3	580	
			8.1	22.6	10.4	67.7		33	1280	
26X12.00-12	10½ JA	8½ JA ; 9½ JA	308	655	297	1959	8PR 112A6	3	1120	
			12.1	25.8	11.7	77.1		44	2470	

Size	Rec. Rim	Alt. Rim	Unloaded Dimensions		SLR	RC	LI/SI or PR	Inflation Pressure	Recommended load, kg (lbs)	
			SW	OD					Speed, km/h(mph)	
			mm	mm					Bar	50
			in	in					Psi	31
29x12.50-15	7J10LB	-	312	755	345	2258	6PR 98B	2.1	750	
			12.3	29.7	13.6	88.9		30	1650	
31X15.50-15	13LB	-	390	800	363	2393	10PR 121B	4.1	1450	
			15.4	31.5	14.3	94.2		59	3200	

IMB 166 - [IMP] [TL]

Backhoe Loader,
Trench Digging,
Tillage and
Orchard Harvesting



Directional Tread Pattern:

- Designed for trailers and agricultural implements both on- and off the road.

Robust Lugs with wider footprint:

- Excellent traction and self-cleaning properties.
- Low Soil Compaction & improved yields.

Superior Carcass Construction:

- Designed for trailers and agricultural implements both on- and off the road.

Robust Lugs with wider footprint:

- High load-carrying capacity and directional stability.



Size	Rim	Unloaded Dimensions		SLR	RC	LI/SI	Inflation Pressure	Recommended load, kg (lbs)							
								Speed, km/h(mph)							
		SW	OD	Free Rolling				Drive Wheel							
		mm	mm	10	25	40		50	10	25	40	50			
in	in	in	in	in	in	Bar	10	25	40	50	10	25	40	50	
							Psi	6	16	25	31	6	16	25	31
320/60-12	10.50 I	324	690	311	2064	"132A8 FR 120 A8 DW"	4	2800	2360	2000	1800	1960	1670	1400	1260
		12.8	27.2	12.3	81.2		58	6160	5190	4400	3960	4310	3670	3080	2770
280/60-15.5	AG8.00	272	745	342	2228	"128 A8 FR 116 A8 DW"	4	2520	2120	1800	1620	1750	1490	1250	1130
		10.7	29.3	13.5	87.7		58	5540	4660	3960	3560	3850	3280	2750	2490



Specially-designed Semi Lug Pattern:

Improves tread wear during trailer application

Strong Nylon Carcass:

High load-carrying capacity

Special Tread Compound:

Longer tyre life and puncture resistance



Tyre Size	PR	TT/TL	Load Index/ Speed Symbol	Rim	Unloaded Inflation Dimension				Static Loaded Radius		Rolling Circumference		Speed		Load-carrying Capacity			
					SW		OD								Max Load		Inflation Pressure	
					mm	in	mm	in	mm	in	mm	in	kmph	mph	kg	lbs	bar	psi
9.00-16	16	TT	137A6	6.00G	248	9.8	912	35.9	412	16.2	2728	107.4	30	19	2300	5070	7.3	105
9.00-16	18	TT	138A6	6.00G	248	9.8	912	35.9	412	16.2	2728	107.4	30	19	2360	5200	7.6	110



Specially designed Lug Pattern:

Suitable for transport applications both on and off the road

Tread pattern with high contact patch:

Provides uniform wear and outstanding stability

Robust Construction:

Higher load-carrying

Special Tread compound:

Longer Tire Life & Puncture resistance



Size	Rim	Unloaded Dimensions		Static Loaded Radius	Rolling Circumference	PR	Inflation Pressure	Recommended load, kg (lbs)	Inflation Pressure	Recommended load, kg (lbs)
		SW	OD					Speed, km/h (mph)		Speed, km/h (mph)
								Single Load		Dual Load
								Bar		30 kmph
in	in	in	in	Psi	19 mph	Psi	19 mph			
10.00-20	7.5	280	1080	490	3230	18	9.3	3845	8.6	3405
		11.0	42.5	19.3	127.2		135	8470	125	7500



- Optimised tread design with improved lateral traction for better operational stability on inclined surfaces and self-cleaning
- Longer cleat length gives low soil compaction, better traction, and higher stability
- Better suitability for grassland, garden & tillage operations



Size	Rim	Unloaded Dimension		SLR	RC	LI/SI or PR	Inflation Pressure	Recommended load, kg (lbs)
		SW	OD					Speed, km/h (mph)
		mm	mm					50
		in	in					31
31X15.50R15	13LB	391	792	360	2369	122B	2.8	1500
		15.4	31.2	14.2	93.3		41	3300
33X15.50R15	13LB	391	843	381	2521	126B	3.2	1700
		15.4	33.2	15.0	99.3		46	3740

Size	Rim	Unloaded Dimensions		SLR	RC	LI/SI or PR	Inflation Pressure	Recommended load, kg (lbs)							
		SW	OD					Speed, km/h (mph)							
		mm	mm					Mixed application							
		in	in					Bar	Static	10	25	30	40	50	65
425/55R17	13	425	881	401	2635	134D	3.5	4880	3820	3350	3200	2880	2570	2120	
		16.7	34.7	15.8	103.7		51	10750	8410	7380	7050	6340	5660	4670	
500/50R17 (SB)	16	503	932	422	2787	145D	4	6670	5220	4580	4380	3940	3510	2900	
		19.8	36.7	16.6	109.7		58	14690	11500	10090	9650	8680	7730	6390	

Note: SB- Steel Belted



Block tread design with Wider footprint

- Excellent Traction.
- Low Soil Compaction & improved yields
- Protection for soil & plants.

SSR compound (Special Stubble Resistant):

- Longer Tire Life and defense against stubble which provides better protection on field.

Advance VF technology:

- Can carry heavy loads at low inflating pressure.

Centre zig-zag rib

- Centre rib improve steering capability and enhance lateral traction.

Extra Strong Casing with High Performance Steel belts:

- Provides exceptional puncture resistance, with even footprint to disperse load equally.
- SB offers better impact resistance and defend against stubble to enhance tire more durable.



Size	Rim	Unloaded Dimensions		SLR	RC	LI/SI or PR	Inflation Pressure	Recommended load, kg (lbs)							
		SW	OD					Speed, km/h (mph)							
								Mixed application							
								Bar	Static	10	25	30	40	50	65
mm	mm	mm	mm	Psi	Kmph	6	16	19	25	31	40				
in	in	in	in												
VF 280/70R15 (SB SG)	8LB	280	773	352	2321	140 D	5.6	5750	4500	3950	3780	3400	3030	2500	
		11.0	30.4	13.9	91.4		81	12670	9910	8700	8330	7490	6670	5510	
VF 320/70R15 (SB SG)	10LB	320	829	375	2489	145 D	5	6670	5220	4580	4380	3940	3510	2900	
		12.6	32.6	14.8	98.0		73	14690	11500	10090	9650	8680	7730	6390	
VF 380/55R16.5 (SB SG)	12	380	837	382	2513	148 D	5	7250	5670	4980	4760	4280	3810	3150	
		15.0	33.0	15.0	99.0		73	15970	12490	10970	10480	9430	8390	6940	
VF 380/60R16.5 (SB SG)	12	380	875	398	2628	147 D	4	7070	5540	4860	4640	4180	3720	3075	
		15.0	34.4	15.7	103.4		58	15570	12200	10700	10220	9210	8190	6770	

Note: VF-Very High Flexion SB-Steel Belted SG-Stubble Guard



- Uniquely designed to protect fields/grasslands and provide rapid self-cleaning
- Excellent forward and reverse traction on inclined surfaces
- Enhanced vehicle stability and manoeuvrability on account of improved sidewall stiffness



Size	Rim	Unloaded Dimension		SLR	RC	LI/SI or PR	Inflation Pressure	Recommended load, kg (lbs)		
		SW	OD					Speed, km/h (mph)		
		mm	mm				mm	mm	Bar	50
		in	in				in	in	Psi	31
31X15.50R15	13LB	391	792	360	2369	122B	2.8	1500		
		15.4	31.2	14.2	93.3		40.6	3300		
33X15.50R15	13LB	391	843	381	2521	126B	3.2	1700		
		15.4	33.2	15	99.3		46.4	3740		

Size	Rim	Unloaded Dimensions		SLR	RC	LI/SI or PR	Inflation Pressure	Recommended load, kg (lbs)							
		SW	OD					Speed, km/h (mph)							
								Mixed application							
								Bar	Static	10	25	30	40	50	65
in	in	in	in	Psi	Kmph	6	16	19	25	31	40				
440/50R17 (SB)	13	441	872	397	2608	135D	3.6	4970	3890	3410	3260	2940	2610	2160	
		17.4	34.3	15.6	102.7		52	10950	8570	7510	7180	6480	5750	4760	
480/45R17 (SB)	16	477	858	392	2566	137D	4	5290	4140	3630	3470	3130	2780	2300	
		18.8	33.8	15.4	101.0		58	11650	9120	8000	7640	6890	6120	5070	
500/50R17 (SB)	16	503	932	422	2787	147D	4.4	7070	5540	4860	4640	4180	3720	3075	
		19.8	36.7	16.6	109.7		64	15570	12200	10700	10220	9210	8190	6770	

Note: SB- Steel Belted

● Flotation





Optimised Flotation Design:

- Reduces soil compaction
- Generates traction
- Self-cleaning properties

Enhanced Carcass Construction:

Ensures high load-carrying capacity



Size	Rim	Unloaded Dimensions		SLR	RC	PR	Free/ Drive Wheel	Inflation Pressure	Recommended load, kg (lbs)									
		SW	OD						Speed, km/h(mph)									
									Free Rolling				Drive Wheel					
		mm	mm						mm	mm	10	25	40	50	10	25	40	50
in	in	in	in	Bar	6	16	25	31	6	16	25	31						
300/65-12	9.00	295	680	307	2042	8	122A8 FR 110AB DW	3	2100	1790	1500	1350	1480	1260	1060	950		
		11.6	26.8	12.1	80.4		44	4620	3938	3300	2970	3256	2772	2332	2090			
400/60-15.5	AG13.00	404	874	395	2625	14	145A8 141B 132A8 128B	3.6	4060	3450	2900	2610	2800	2380	2000	1800		
		15.9	34.4	15.6	103.3		52	8932	7590	6380	5742	6160	5236	4400	3960			
400/60-15.5	AG13.00	404	874	395	2625	16	148A8 144A 136A8 132B	4.2	4410	3750	3150	2840	3140	2670	2240	2016		
		15.9	34.4	15.6	103.3		61	9702	8250	6930	6248	6908	5874	4928	4435			
400/60-15.5	AG13.00	404	874	395	2625	18	151A8 147B 139A8 135B	5	4830	4110	3450	3110	3400	2890	2430	2190		
		15.9	34.4	15.6	103.3		73	10626	9042	7590	6842	7480	6358	5346	4818			
480/45-17	16	479	864	394	2595	16	150 AB FR 138 AB DW	3.6	4690	3990	3350	3020	3300	2810	2360	2120		
		18.9	34.0	15.5	102.1		52	10318	8778	7370	6644	7260	6182	5192	4664			
500/50-17	16	503	932	423	2788	14	149A8 145B 137A8 133B	2.8	4550	3870	3250	2930	3220	2740	2300	2070		
		19.8	36.7	16.7	109.8		41	10010	8514	7150	6446	7084	6028	5060	4554			
500/50-17	16	503	932	423	2788	18	157A8 154B 145A8 142B	4	5780	4910	4125	3710	4060	3450	2900	2610		
		19.8	36.7	16.7	109.8		58	12716	10802	9075	8162	8932	7590	6380	5742			
500/45-22.5	16	513	1022	472	3057	16	154A8 150B 142A8 138B	3.6	5250	4460	3750	3380	3710	3150	2650	2385		
		20.2	40.2	18.6	120.4		52	11550	9812	8250	7436	8162	6930	5830	5247			
500/50-22.5	AG16.00	500	1070	534	3213	20	163A8 159B 151A8 147B	3.8	6830	5800	4875	4390	4830	4110	3450	3110		
		19.7	42.1	21	126.5		55	15026	12760	10725	9658	10626	9042	7590	6842			
400/55-22.5	13	404	1020	534	3063	14	152A8 149B 140A8 136B	3	4690	3990	3350	3020	3300	2810	2360	2124		
		15.8	40	21	120.6		44	10318	8778	7370	6644	7260	6182	5192	4673			
400/55-22.5	13	404	1020	534	3063	16	150A8 146B 138A8 134B	4	4970	4220	3550	3200	3500	2980	2500	2250		
		15.9	40.2	21	120.6		58	10934	9284	7810	7040	7700	6556	5500	4950			
500/60-22.5	16	503	1172	492	3506	16	163A8 159B 151A8 148B	3.2	6830	5800	4875	4390	4830	4110	3450	3105		
		19.8	46.1	19	138		46	15026	12760	10725	9658	10626	9042	7590	6831			
500/60-22.5	16	503	1172	492	3506	20	170A8 167B 158A8 155B	5	8400	7140	6000	5400	5950	5060	4250	3825		
		19.8	46.1	19	138		73	18480	15708	13200	11880	13090	11132	9350	8415			





Size	Rim	Unloaded Dimensions		SLR	RC	PR	Free/ Drive Wheel	Inflation Pressure	Recommended load, kg (lbs)								
		SW	OD						Speed, km/h(mph)								
				Free Rolling				Drive Wheel									
		mm	mm	mm	mm	mm	mm	mm	mm	mm	mm	mm	mm	mm			
in	in	in	in	in	in	in	in	in	in	in	in	in	in				
LI/SI	Bar	10	25	40	50	10	25	40	50	10	25	40	50				
	Psi	6	16	25	31	6	16	25	31	6	16	25	31				
550/45-22.5	16	558	1070	562	3201	16	159A8 156B 158A8 155B	☉	2.8	6130	5210	4375	3940	4310	3660	3075	2767.5
		22	42	22.1	126			☉	41	13486	11462	9625	8668	9482	8052	6765	6089
550/45-22.5	16	558	1070	562	3201	20	166A8 162B 154A8 150B	☉	4	7420	6310	5300	4770	5250	4460	3750	3375
		22	42	22.1	126			☉	58	16324	13882	11660	10494	11550	9812	8250	7425
550/60-22.5	16	553	1240	562	3709	16	166A8 162B 154A8 150B	☉	3	7420	6310	5300	4770	5250	4460	3750	3375
		21.8	48.8	22.1	146			☉	44	16324	13882	11660	10494	11550	9812	8250	7425
550/60-22.5	16	553	1240	562	3709	20	171A8 167B 158A8 154B	☉	3.5	8610	7320	6150	5540	5950	5060	4250	3825
		21.8	48.8	22.1	146			☉	51	18942	16104	13530	12188	13090	11132	9350	8415
550/60-22.5 V	16	553	1240	562	3709	16	166A8 162B 154A8 150B	☉	3	7420	6310	5300	4770	5250	4460	3750	3375
		21.8	48.8	22.1	146			☉	44	16324	13882	11660	10494	11550	9812	8250	7425
600/50-22.5	20	611	1172	534	3506	16	165A8 161B 153A8 149B	☉	2.8	7210	6130	5150	4640	5110	4340	3650	3285
		24.1	46.1	21	138			☉	41	15862	13486	11330	10208	11242	9548	8030	7227
700/40-22.5	24	727	1140	521	3410	16	166A8 162B 154A8 150B	☉	2.6	7420	6310	5300	4770	5250	4460	3750	3375
		28.6	44.9	20.5	134.3			☉	38	16324	13882	11660	10494	11550	9812	8250	7425
700/50-22.5	24	727	1270	574	3799	16	174A8 170B 162A8 158B	☉	2.8	9380	7970	6700	6030	6650	5650	4750	4275
		28.6	50	22.6	149.6			☉	41	20636	17534	14740	13266	14630	12430	10450	9405
600/55-22.5	20	611	1232	559	3799	16	169A8 166B 156A8 153B	☉	2.6	8120	6900	5800	5220	5600	4760	4000	3600
		24.1	48.5	22	149.6			☉	38	17864	15180	12760	11484	12320	10472	8800	7920
600/55-26.5	20	611	1333	609	3987	16	170A8 167B 159A8 156B	☉	2.6	8400	7140	6000	5400	6130	5210	4375	3938
		24.1	52.5	24	157			☉	38	18480	15708	13200	11880	13486	11462	9625	8663
700/50-26.5	24	727	1333	609	3987	16	174A8 170B 162A8 158B	☉	2.4	9380	7970	6700	6030	6650	5650	4750	4275
		28.6	52.5	24	157			☉	35	20636	17534	14740	13266	14630	12430	10450	9405
800/45-26.5	28	828	1393	634	4167	16	177A8 173B 164A8 160B	☉	2.2	10220	8690	7300	6570	7000	5950	5000	4500
		32.6	54.8	25	164.1			☉	32	22484	19118	16060	14454	15400	13090	11000	9900



Steel Belted Directional Tread for Superior Traction:

- Homogenous pattern for on-road and farm applications
- Tyres designed for high load and speed operations
- Ensure traction and self-cleaning during field operation
- Enhanced roadability and better mileage



Size	Rim	Unloaded Dimensions		SLR	RC	LI/SI or PR	Inflation Pressure	Recommended load, kg (lbs)						
		SW	OD					Speed, km/h (mph)						
								Mixed application						
								Bar	Static	10	25	30	40	50
Psi	6	16	19	25	31	40								
500/50R17 (SB)	16	503	932	422	2787	149D	5	7480	5850	5140	4910	4420	3930	3250
		19.8	36.7	16.6	109.7		73	16480	12890	11320	10810	9740	8660	7160
560/45R22.5 (SB)	AG16.00	543	1075	493	3215	152D	4	8170	6390	5610	5360	4830	4300	3550
		21.4	42.3	19.4	126.6		58	18000	14070	12360	11810	10640	9470	7820
620/40R22.5 (SB)	AG20.00	625	1068	491	3207	154D	4	8630	6750	5930	5660	5100	4540	3750
		24.6	42.0	19.3	126.3		58	19010	14870	13060	12470	11230	10000	8260
600/50R22.5 (SB)	AG20.00	611	1172	534	3505	159D	4	10060	7880	6910	6610	5950	5290	4375
		24.1	46.1	21	138		58	22160	17360	15220	14560	13110	11650	9640
500/60R22.5 (SB)	AG16.00	503	1172	533	3519	155D	4	8910	6980	6120	5850	5270	4690	3875
		19.8	46.1	21.0	138.5		58	19630	15370	13480	12890	11610	10330	8540
560/60R22.5 (SB)	AG16.00	543	1249	565	3735	164D	5	11500	9000	7900	7550	6800	6050	5000
		21.4	49.2	22.2	147		73	25330	19820	17400	16630	14980	13330	11010
710/50R26.5 (SB)	AG24.00	726	1383	629	4136	170D	4	13800	10800	9480	9060	8160	7260	6000
		28.6	54.4	24.8	162.8		58	30400	23790	20880	19960	17970	15990	13220
600/55R26.5 (SB)	AG20.00	611	1333	609	3987	165D	4	11850	9270	8140	7780	7000	6230	5150
		24.1	52.5	24	157		58	26100	20420	17930	17140	15420	13720	11340
650/55R26.5 (SB)	AG20.00	645	1389	632	4171	170D	4.5	13800	10800	9480	9060	8160	7260	6000
		25.4	54.7	24.9	164.2		65	30400	23790	20880	19960	17970	15990	13220
650/55R26.5 (SB)	AG20.00	645	1389	632	4171	178D	6	17250	13500	11850	11330	10200	9080	7500
		25.4	54.7	24.9	164.2		87	38000	29740	26100	24960	22470	20000	16520
650/60R26.5 (SB)	AG20.00	655	1450	657	4354	180D	6	18400	14400	12640	12080	10880	9680	8000
		25.8	57.1	25.9	171.4		87	40530	31720	27840	26610	23960	21320	17620
750/45R26.5 (SB)	AG24.00	754	1349	615	4035	170D	4	13800	10800	9480	9060	8160	7260	6000
		29.7	53.1	24.2	158.9		58	30400	23790	20880	19960	17970	15990	13220

FTR 170 - [IMP] [TL]



Implements,
Trailers,
Slurry Tankers,
Dump Trailer



Size	Rim	Unloaded Dimensions		SLR	RC	LI/SI or PR	Inflation Pressure	Recommended load, kg (lbs)						
		SW	OD					Speed, km/h (mph)						
								Mixed application						
								Bar	Static	10	25	30	40	50
Psi	6	16	19	25	31	40								
800/45R26.5 (SB)	AG28.00	828	1393	634	4183	174D	4	15410	12060	10590	10120	9110	8110	6700
		32.6	54.8	24.9	164.7		58	33940	26560	23330	22290	20070	17860	14760
710/50R30.5 (SB)	AG20.00	686	1485	680	4441	176D	4.4	16330	12780	11220	10720	9660	8590	7100
		27	58.5	26.8	174.8		64	35970	28150	24710	23610	21280	18920	15640
750/60R30.5 (SB)	AG24.00	754	1675	759	5010	181D	4	18980	14850	13040	12460	11220	9980	8250
		29.7	65.9	29.9	197.2		58	41810	32710	28720	27440	24710	21980	18170
850/50R30.5 (SB)	AG28.00	862	1625	738	4880	182 D	4	19550	15300	13430	12840	11560	10290	8500
		33.9	64	29.1	192.1		58	43060	33700	29580	28280	25460	22670	18720

Note: SB - Steel Belt

● Irrigation





Specially Designed Tread Pattern:

Excellent traction and outstanding self-cleaning properties

Robust Nylon Carcass Construction:

Enhances its ability to carry continuous heavy loads

Special Tread Compound:

Minimises wear and extends tyre life significantly



Size	Rim	Unloaded Dimensions		SLR	RC	LI/SI or PR	Inflation Pressure	Recommended load, kg (lbs)							
								Speed, km/h(mph)							
		Field Operation			Road Operation; Not high and sustained Torque										
		High Torque	Low Torque												
		Bar	10	10	20			Static	10	20	30	40			
Psi	6	6	12		6	12	19	25							
11.2-24	W10	284	1103	509	3299	6PR 110A8	1.8	1130	1590	1300	2440	1590	1300	1130	1060
		11.2	43.4	20.0	129.9		26	2490	3500	2860	5370	3500	2860	2490	2330
14.9-24	W13	378	1252	570	3745	8PR 128A8	1.8	1930	2700	2210	4140	2700	2210	1930	1800
		14.9	49.3	22.4	147.4		26	4250	5950	4870	9120	5950	4870	4250	3960
11.2-38	W10	284	1459	687	4364	6PR 114A8	1.8	1260	1770	1450	2710	1770	1450	1260	1180
		11.2	57.4	27.0	171.8		26	2780	3900	3190	5970	3900	3190	2780	2600

● Telehandler





Specially Designed Directional Tread Pattern:

- Ensures traction & self-cleaning properties
- Provides excellent stability during vehicle operation

Strong Nylon Carcass:

Safeguards the tyre against failures



Size	Rim	Unloaded Dimension		SLR	RC	LI/SI or PR	Inflation Pressure	Recommended load, kg (lbs)	
		SW	OD					Speed, km/h (mph)	
		mm	mm					Bar	40
		in	in					Psi	25
15.5/80-24 (400/80-24)	W12	394	1266	576	3787	12PR	3	4125	
		15.5	49.8	22.7	149.1	157A8	44	9100	
15.5/80-24 (400/80-24)	W12	394	1266	576	3787	16PR	4	4875	
		15.5	49.8	22.7	149.1	163A8	59	10725	

Size	Rim	Unloaded Dimension		SLR	RC	LI/SI or PR	Inflation Pressure	Recommended load, kg (lbs)	
		SW	OD					Speed, km/h (mph)	
		mm	mm					Bar	50
		in	in					Psi	31
405/70-20 (16.0/70-20)	13	418	1075	488	3216	14PR	3.5	3250	
		16.5	42.3	19.2	126.6	149B	51	7150	
405/70-24 (16.0/70-24) (SB SG)	13	418	1177	539	3521	14PR	3.5	3550	
		16.5	46.3	21.2	138.6	149B	51	7810	

Robust Tread Design:

- Higher radial stiffness to reduce deflection in tires enhances mobility
- Ideal tire for soft surfaces and heavy-duty service

Strong Nylon Carcass:

Helps to carry higher load, protects against sudden shock

Improved Compound:

Which performs well in higher temperature application



Size	Rim	Unloaded Dimension		SLR	RC	LI/SI or PR	Inflation Pressure	Recommended load, kg (lbs)
		SW	OD					Speed, km/h (mph)
		mm	mm					40
		in	in					25
15.5/80-24 (400/80-24) HD	W12	394	1266	576	3787	12PR 157A8	3	4125
		15.5	49.8	22.7	149.1		44	9100
15.5/80-24 (400/80-24) HD	W12	394	1266	576	3787	16PR 163A8	4	4875
		15.5	49.8	22.7	149.1		59	10725

● Multi-Purpose





Large Tread Area:

Increases flotation and minimises ground disturbance in soil

Optimised Diamond Lug Pattern with Sipes:

Reduces groove cracks, minimises slippage, and enhances productivity

Heavy Under Tread:

Ensures puncture and impact resistance, thereby reducing downtime



Size	Rim	Unloaded Dimension		SLR	RC	LI/SI or PR	Inflation Pressure	Recommended load, kg (lbs)
		SW	OD					Speed, km/h (mph)
		mm	mm					Bar
		in	in					Psi
23.1-26 (DB)	DW20B	587	1581	710	4748	18PR 170A8	2.6	6000
		23.1	62.2	28.0	186.9		38	13220

Size	Rim	Unloaded Dimension		SLR	RC	LI/SI or PR	Inflation Pressure	Recommended load, kg (lbs)
		SW	OD					Speed, km/h (mph)
		mm	mm					Bar
		in	in					Psi
620/75-30 (23.1-30) (DB)	DW20A DW20B	605	1675	758	5010	16PR 161A6	2.3	4625
		23.8	65.9	29.8	197.2		33	10190
620/75-30 (23.1-30) (DB)	DW20A DW20B	605	1675	758	5010	18PR 164 A6	2.6	5000
		23.8	65.9	29.8	197.2		38	11010
650/75-32 (24.5-32) (DB)	DH21 DH21B	625	1755	795	5249	16PR 164A6	2.1	5000
		24.6	69.1	31.3	206.7		30	11010
650/75-32 (24.5-32) (DB)	DH21 DH21B	625	1755	795	5249	18PR 167A6	2.4	5450
		24.6	69.1	31.3	206.6		35	12000

Note: DB- Dual Bead



- Optimised tread design provides quiet run at high speeds
- Carcass optimised for better ride comfort
- Tread design optimised for better mileage and fuel efficiency



Size	Rim	Unloaded Dimensions		SLR	RC	PR	Free/ Drive Wheel	Inflation Pressure	Recommended load, kg (lbs)									
									Speed, km/h(mph)									
		SW	OD	mm	mm	mm	mm	LI/SI	Bar	15	20	30	40	50	65	80	90	100
		in	in						in	in	Psi	9	12	19	25	31	40	50
355/60R18 (SB)	11	353	883	404	2641	16	142J	6	4370	3980	3310	3050	2970	2880	2760	2700	2650	
		13.9	34.8	15.9	104.0			87	9630	8770	7290	6720	6540	6340	6080	5950	5840	

Note: SB- Steel Belted

● Lawn & Garden





Directional Block Tread Design with Deeper Tread:

- High Traction.
- Excellent Roadability.
- Combine the best aspects of lug-style R-1 and R-4 designs results in R-3+ tire.

Larger Footprint with more Void:

- Protection for soil & plants.
- Low Rolling resistance results in better fuel economy.

Special Rubber compound:

- Longer Tire Life and provides even wear on hard surfaces.



Size	Rim	Unloaded Dimensions		SLR	RC	LI/SI or PR	Inflation Pressure	Recommended load, kg (lbs)					
		SW	OD					Speed, km/h(mph)					
		Constant Load											
		mm	mm					Static	10	25	30	40	50
		in	in						6	16	19	25	31
220/55R12	7.00B/ 7.00-I-90	220	550	254	1645	82A8/B	1.9	1090	710	530	510	475	475
		8.7	21.7	10.0	64.8		28	2400	1560	1170	1120	1050	1050
240/60R12	8.00B / 8.00-I-90	244	593	271	1774	89 A8/B	2.4	1330	870	640	620	580	580
		9.6	23.3	10.7	69.8		35	2930	1920	1410	1370	1280	1280
220/55R14	7JA/ 7.00-I-70	220	598	278	1788	93A8/B	2.6	1500	980	720	700	650	650
		8.7	23.5	10.9	70.4		38	3300	2160	1590	1540	1430	1430
200/60R15	7JA / 7.00-I-70	197	621	290	1857	83 A8/B	1.9	1120	730	540	520	487	487
		7.8	24.4	11.4	73.1		28	2470	1610	1190	1150	1070	1070
200/65R16	W6	197	666	310	1992	94 A8/B	2.6	1540	1010	740	720	670	670
		7.8	26.2	12.2	78.4		38	3390	2220	1630	1590	1480	1480
200/70R16	W6	197	686	319	2052	94 A8/B	2.4	1540	1010	740	720	670	670
		7.8	27.0	12.6	80.8		35	3390	2220	1630	1590	1480	1480
240/70R16	W8	244	742	342	2219	104 A8/B	2.4	2070	1350	1000	960	900	900
		9.6	29.2	13.5	87.4		35	4560	2970	2200	2110	1980	1980
260/70R16	W8	258	770	353	2303	109A8/B	2.4	2370	1550	1140	1100	1030	1030
		10.2	30.3	13.9	90.7		35	5220	3410	2510	2420	2270	2270
280/70R16	W8L	272	798	365	2387	112 A8/B	2.4	2580	1680	1240	1200	1120	1120
		10.7	31.4	14.4	94.0		35	5680	3700	2730	2640	2470	2470
260/70R18	W8	258	821	379	2455	114A8/B	2.8	2710	1770	1310	1260	1180	1180
		10.2	32.3	14.9	96.7		41	5970	3900	2890	2780	2600	2600
280/70R18	W8L	272	849	390	2539	114A8/B	2.4	2710	1770	1310	1260	1180	1180
		10.7	33.4	15.4	100.0		35	5970	3900	2890	2780	2600	2600

Size	Rim	Unloaded Dimensions		SLR	RC	LI/SI or PR	Inflation Pressure	Recommended load, kg (lbs)					
		SW	OD					Speed, km/h(mph)					
		mm	mm					Constant Load					
		in	in	Static	10			25	30	40	50		
					6			16	19	25	31		
300/70R20	W9	295	952	437	2847	110 A8/B	1.6	2440	1590	1180	1130	1060	1060
		11.6	37.5	17.2	112.1		23	5370	3500	2600	2490	2330	2330
320/70R20	W10	319	982	450	2937	113 A8/B	1.6	2650	1730	1280	1230	1150	1150
		12.6	38.7	17.7	115.6		23	5840	3810	2820	2710	2530	2530
380/70R20	W12	380	1082	491	3236	122A8/B	1.6	3450	2250	1670	1610	1500	1500
		15.0	42.6	19.3	127.4		23	7600	4960	3680	3550	3300	3300
380/70R24	W12	380	1190	544	3559	125A8/B	1.6	3800	2480	1830	1770	1650	1650
		15.0	46.9	21.4	140.1		23	8370	5460	4030	3900	3630	3630
420/70R24	W13	418	1248	568	3733	130 A8/B	1.6	4370	2850	2110	2030	1900	1900
		16.5	49.1	22.4	147		23.2	9630	6280	4650	4470	4190	4190

● Forestry



● Agro Forestry





Robust Lug Design:

- Combination of robust lugs used in forestry applications & good self-cleaning properties

Flat and Wider Tread:

- Excellent stability during vehicle operation

Specially Designed Tread Compound:

- Ensures longer tyre life in forestry application



Size	Rim	Unloaded Dimension		SLR	RC	LI/SI or PR	Inflation Pressure	Recommended load, kg (lbs)			
		SW	OD					Speed, km/h (mph)			
								Mixed application			
								Bar	10	25	30
		mm	mm	mm	mm		Psi	6	16	19	25
		in	in	in	in						
18.4-26	DW16	467	1450	656	4337	16PR 156A8	2.5	6000	4920	4280	4000
		18.4	57.1	25.8	170.7		36	13220	10840	9430	8810



Robust Lug Design:

Lug is designed for excellent grip, high traction abilities, low slip, suitable for many kinds of Agro-Forestry uses

Reinforced Sidewall:

Reinforced sidewall and high turn of plies around strong bead to guarantee minimum impact and perforation

Special compound equipped with Steel belt:

To reduce the risk of tire puncture and cut due to branches, tree stumps or stone, AFB 821 tractor tire has **steel belt protection**, strong carcass and **puncture resistant compound** suitable for Agro Forestry work



Size	Rim	Unloaded Dimension		SLR	RC	LI/SI or PR	Inflation Pressure	Recommended load, kg (lbs)			
		SW	OD					Speed, km/h (mph)			
		Mixed application									
		mm	mm					10	25	30	40
in	in	in	in	Bar	6	16	19	25			
12.4-24 (SB) (CR)	W11	315	1159	531	3480	16PR 130A8	2.8	2850	2340	2030	1900
		12.4	45.6	20.9	137.0		4.1	6280	5150	4470	4190
13.6-24 (SB) (CR)	W12	345	1210	552	3634	16PR 136A8	2.8	3360	2760	2400	2240
		13.6	47.6	21.7	143.1		4.1	7400	6080	5290	4930
14.9-24 (SB) (CR)	W13	378	1265	575	3799	16PR 140A8	2.8	3750	3080	2680	2500
		14.9	49.8	22.6	149.6		4.1	8260	6780	5900	5510
16.9-30 (SB) (CR)	W15L	429	1485	679	4459	16PR 149A8	2.8	4880	4000	3480	3250
		16.9	58.5	26.7	175.6		4.1	10750	8810	7670	7160
18.4-30 (SB) (CR)	W16L	467	1552	707	4660	16PR 151A8	2.8	5180	4240	3690	3450
		18.4	61.1	27.8	183.5		4.1	11410	9340	8130	7600
16.9-34 (SB) (CR)	W15L	429	1587	730	4766	16PR 151A8	2.8	5180	4240	3690	3450
		16.9	62.5	28.7	187.6		4.1	11410	9340	8130	7600
18.4-34 (SB) (CR)	W16L	467	1654	758	4967	16PR 155A8	2.8	5810	4770	4150	3875
		18.4	65.1	29.8	195.6		4.1	12800	10510	9140	8540

Note: SB - Steel Belted, CR - Cut Resistant

● Log Skidder



LSB 780 - [LS-2] [TL]



Log Skidder



- Uncompromising tread design for excellent self-cleaning and longer tread life
- Optimised lateral stiffness provides better steer control and manoeuvrability on wet and dry surfaces
- Reinforced carcass & shoulder areas with special compound for protection from frequent puncture & cut



Size	Rim	Unloaded Dimension		SLR	RC	LI/SI or PR	Inflation Pressure	Recommended load, kg (lbs)					
		SW	OD					Cable/Grapple Skidder	Speed, km/h (mph)				
									Mixed application				
									Bar	10	Static	15	25
mm	mm	mm	mm	Psi	6	Kmph	9	16	19	25			
in	in	in	in										
23.1-26 (SB)	DW20B	587	1632	731	4881	16PR 160A6 172A2	2.4	-	12150	5400	4950	4500	4050
							34.8	-	26760	11890	10900	9910	8920
		23.1	64.3	28.8	192.2		2.8	6300	-	-	-	-	-
							40.6	13880	-	-	-	-	-

Size	Rim	Unloaded Dimension		SLR	RC	LI/SI or PR	Inflation Pressure	Recommended load, kg (lbs)					
		SW	OD					Cable/Grapple Skidder	Speed, km/h (mph)				
									Mixed application				
									Bar	Static	15	25	30
mm	mm	mm	mm	Psi	Kmph	9	16	19	25				
in	in	in	in										
18.4-26 (SB)	DW16A	467	1476	667	4414	16PR 152 A6	2.8	9590	4260	3910	3550	3195	
		18.4	58.1	26.2	173.8		40	21120	9380	8610	7820	7040	
28L-26 (SB & DB)	DW25B	714	1644	736	4917	20PR 165A6	2.4	13910	6180	5670	5150	4635	
		28.1	64.7	29.0	193.6		35	30640	13610	12490	11340	10210	
24.5-32 (SB & DB)	DH21	622	1831	826	5476	20PR 169 A6 181A2	2.75	15660	6960	6380	5800	5220	
		24.5	72.1	32.5	215.6		40	34490	15330	14050	12780	11500	
30.5L-32 (SB & DB)	DH27	775	1847	833	5524	20PR 170 A6	2.1	16200	7200	6600	6000	5400	
		30.5	72.7	32.8	217.5		30	35680	15860	14540	13220	11890	
30.5L-32 (SB & DB)	DH27	775	1847	833	5524	26PR 176A6	2.8	19170	8520	7810	7100	6390	
		30.5	72.7	32.8	217.5		40	42220	18770	17200	15640	14070	
30.5L-32 (SB & DB)	DH27	775	1847	833	5524	32PR 180A6	3.4	21600	9600	8800	8000	7200	
		30.5	72.7	32.8	217.5		49	47580	21150	19380	17620	15860	
35.5L-32 (SB & DB)	DH31H	902	2011	901	6014	26PR 183 A6	2.4	23630	10500	9630	8750	7875	
		35.5	79.2	35.5	236.8		35	52050	23130	21210	19270	17350	

Note: SB- Steel Belted DB- Dual Bead

LSB 780 - [LS-2] [TL]



Log Skidder



Size	Rim	Unloaded Dimension		SLR	RC	LI/SI or PR	Inflation Pressure	Recommended load, kg (lbs)							
		SW	OD					Speed, km/h (mph)							
		mm	mm					Mixed application							
		in	in					mm	mm	Bar	Static	15	25	30	40
		in	in					in	in	Psi	Kmph	9	16	19	25
35.5L-32 (SB & DB)	DH31H	902	2011	736	6014	32PR 187 A6	3	26330	11700	10730	9750	8775			
		35.5	79.2	29.0	236.8		44	58000	25770	23630	21480	19330			

● Forestry Forwarder





- FFB 840 is a bias steel-belted tyre, suitable for forestry applications with forwarders and harvesters.
- The unique tread design and lug angle provide high traction and low slip abilities for improved fuel economy.
- With extensive inter-lug space provides Excellent self-cleaning properties and functions well with or without tracks, but tracks can be added for more demanding environments.
- The tyre is equipped with reinforced steel belt for increased resistance to punctures and high load carrying capacity.
- The Reinforced bead area provides resistant to rim slip.
- Large tread width contributes to low soil compaction and driver comfort by providing the wider footprint.
- A Special tread and sidewall compound coupled with robust sidewalls and a high under tread, offers enhanced puncture resistance.



Size	Rim	Unloaded Dimension		SLR	RC	LI/SI or PR	Inflation Pressure	Recommended load, kg (lbs)				
		SW	OD					Speed, km/h (mph)				
								Forestry Service (LT)	Skidder Service (HT)	Road application		
										10	10	20
mm	mm	mm	mm	Bar	6	6	16	19	25			
in	in	in	in	Psi	6	6	16	19	25			
710/40-22.5 (SB)	AG24.00	705	1170	533	3513	20PR 161A8 HT -161A2 LT -168A2	5	5600	4625	5690	4950	4625
		27.8	46.1	21.0	138.3		73	12330	10190	12530	10900	10190
600/55-26.5 (SB)	AG20.00	600	1345	614	4039	20PR 165A8 HT -165A2 LT -172A2	5	6300	5150	6330	5510	5150
		23.6	53	24.2	159		73	13880	11340	13940	12140	11340
710/45-26.5 (SB)	AG24.00	705	1345	614	4039	20PR 168A8 HT -168A2 LT -175A2	5	6900	5600	6890	5990	5600
		27.8	53	24.2	159		73	15200	12330	15180	13190	12330
800/40-26.5 (SB)	AG28.00	800	1345	614	4039	20PR 170A8 HT -170A2 LT -177A2	5	7300	6000	7380	6420	6000
		31.5	53	24.2	159		73	16080	13220	16260	14140	13220

Note: SB - Steel Belted

● Tyre Care & Usage



- **Section Height:**

The height of a tyre from the nominal rim diameter to the top of the tread.

- **Section Width:**

The width of a tyre including normal sidewalls, but not including protective side ribs, bars, or other decorations.

- **Overall Diameter:**

Twice the section height (unloaded) plus the nominal rim diameter.

- **Rim Width:**

The measurement on the inside of the rim between the two flanges.

- **Rim Diameter Code:**

The nominal rim diameter in inches.

- **Rolling Circumference:**

The distance an inflated and loaded tyre will roll in one revolution.

- **Aspect Ratio:**

Used to describe the ratio of tyre "section height" to "section width."

A tyre with an aspect ratio of 85 would have a tyre section height equal to 85% of the tyre's width.

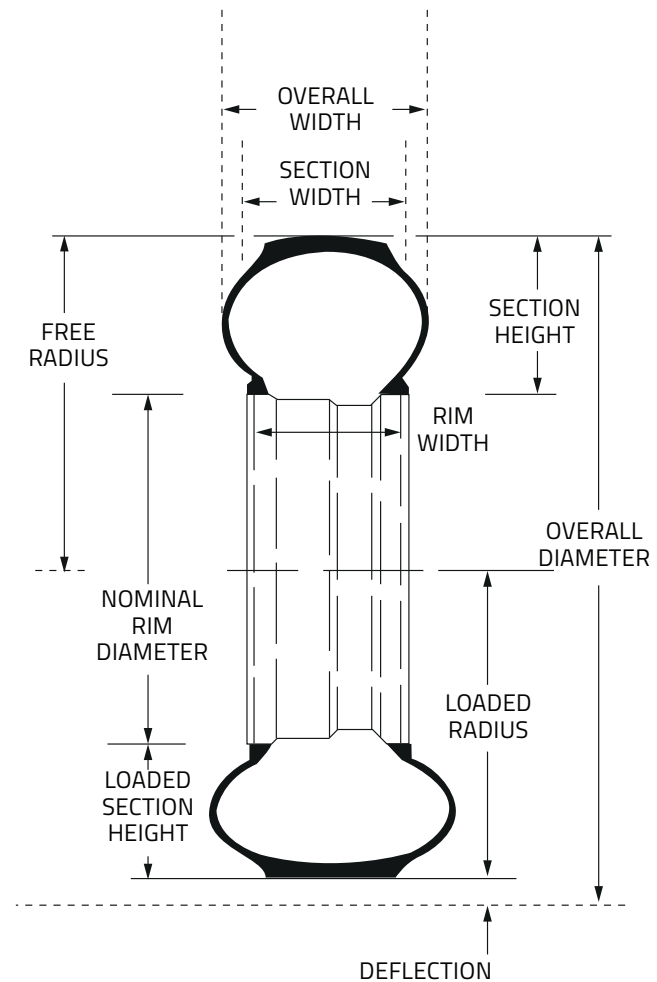

Conversion factors

1 millimetre (mm)	= 0.03937 inches	1 inch (")	= 25.4 millimetres
1 metre (m)	= 1.09361 yards	1 yard	= 0.9144 metres
1 kilometre (km)	= 0.62137 miles	1 mile (mi)	= 1.609344 kilometres
1 litre (l)	= 0.21997 gallons (UK)	1 gallon (UK)	= 4.5461 litres
1 litre (l)	= 0.26417 gallons (USA)	1 gallon (USA)	= 3.7854 litres
1 gram (g)	= 0.035274 ounces	1 ounce (oz)	= 28.34952 grams
1 kilogram (kg)	= 2.205 pounds	1 pound (lb)	= 0.45359 kilograms
1 kilometre per hour (km/h)	= 0.62137 miles per hour	1 mile per hour (mph)	= 1.609344 kilometres per hour
1 kilopascal (kPa)	= 0.145 pounds per square inch	1 pound per square inch (psi)	= 6.895 kilopascal
1 bar	= 100 kilopascal	1 pound per square inch (psi)	= 0.06895 bar
1 kilowatt (kW)	= 1.34 horsepower	1 horsepower (HP)	= 0.746 kilowatts
1 Newton metre (N.m)	= 0.113 inch pound	1 inch pound (in-lb)	= 8.85 inch-pound

Pressure conversion table

PSI	BAR	KPA
10	0.7	70
11	0.8	80
12	0.9	90
13	0.8	80
14	1	100
15	1	100
16	1.1	110
17	1.2	120
18	1.2	120
19	1.3	130
20	1.4	140
21	1.4	140
22	1.5	150
23	1.6	160
24	1.7	170
25	1.7	170
26	1.8	180
27	1.9	190
28	1.9	190

PSI	BAR	KPA
29	2	200
30	2.1	210
31	2.2	220
32	2.1	210
33	2.3	230
34	2.3	230
35	2.4	240
36	2.5	250
37	2.6	260
38	2.6	260
39	2.7	270
40	2.8	280
41	2.8	280
42	2.9	290
43	3	300
44	3	300
45	3.1	310
46	3.2	320
47	3.2	320

PSI	BAR	KPA
48	3.3	330
49	3.4	340
50	3.5	350
51	3.4	340
52	3.6	360
53	3.7	370
54	3.7	370
55	3.8	380
56	3.9	390
57	3.9	390
58	4	400
59	4.1	420
60	4.1	410
61	4.2	420
62	4.3	430
63	4.3	430
64	4.4	440
65	4.5	450
66	4.5	450

Storage

- Keep the tyres clean and away from heat, light, ozone or hydrocarbon sources.
- Avoid prolonged exposure of the tyres to direct sunlight.
- Avoid any contact with grease, petrol, volatile solvents or other substances that may deteriorate the rubber.
- Avoid horizontal storage for tubeless tyres, only small size tyres may be stacked or stored flat (maximum 6 months).
- When tyres are stored flat (horizontal), the position must be lug against lug.
- Reduce inflation pressure when tyres are stored fitted on rims.
- Ensure there is no water or moisture inside the tyre.
- Never store tyres directly in contact with the ground for long periods.

Tyre repairs

For safety reasons, repairs should only be carried out by specialists using the correct tools.

Proper use of tyres

- When loading tyres you have to consider the correlation between speed, inflation pressure and load capacity.
- Overloading results in premature tyre failure. Use the technical documentation and inflation tables which show the load and pressure figures for different operating speeds.
- Underinflation results not only in incorrect tread wear but also in ply separation and eventually further damage to the ply. Overinflation makes the tyre stiff and decreases its resistance against hits, leading to ply tear.

Demounting and mounting procedures can be dangerous, and should be performed only by trained and qualified staff, using proper tools and procedures. Failure to comply with these procedures may result in faulty positioning of the tyre on the rim, and cause the tyre to burst with explosive force leading to serious physical injury or death.

Fitting

- 01.** Make sure that the rim, the tyre and the tube are compatible.
- 02.** Check that the tyre is suitable for the machine. Use only rims recommended or permitted by the tyre manufacturer.
- 03.** Always use the proper specialised equipment and tools.
- 04.** The rim must be clean and in perfect condition (no damage, etc.). If necessary, clean the rim thoroughly with a wire brush. Never fit a tyre onto a rim that shows cracks, significant distortion, and evidence of welded repair.
- 05.** Thoroughly inspect the inside as well as the outside of the tyre in order to identify any damage which may be present. If the damage is considered to be beyond repair, the tyre should be scrapped.
- 06.** If fitting with a tube, always use the correct new tube and flap for the tyre size. For fitting tubeless tyres without tubes, on tubeless rims, always use a new tubeless valve.
- 07.** Before fitting, lubricate the rim and the beads. Use only a suitable lubricant that will not damage the tyre (never use silicone or petroleum-based products).
- 08.** We recommend vertical fitting. In case of a horizontal fitting, it is impossible to see if the lower bead is correctly seated.
- 09.** Fit the tyre on the rim diametrically opposite to the valve hole (respect, if present, the rotation direction indicated by the arrows). with the help of a suitable lever and closely repeated applications, get the first bead over the rim flange. Then pose the lightly inflated talc coated tube (if fitted) inside the tyre. Locate the valve, fitting the ferrule loosely. Fit the second bead, lever it progressively over the rim flange, finish at the valve.
- 10.** For seating the beads and centring of the tyre, remove the valve core. Slowly inflate to ensure correct seating of the beads. Ensure that the beads do not pinch the tube.
- 11.** While inflating a tyre keep at a safe distance and always use a safety cage. If possible, fasten the tyre to the wall or use retaining chains. During pressure readings, ensure that no part of the body is within the possible trajectory of the valve mechanism or of the caps. It is recommended to use suitable pressure limitation gauges. Use a filter and dehumidifier on the compressed air line to avoid introducing humidity or dirt. Never use a hammer to make a tyre bead seat by hitting it.
- 12.** Continue inflation. Make sure that you do not inflate beyond 2.5 bar if the beads are not well seated and centred on the wheel.
- 13.** If the beads are not correctly seated, deflate, lubricate and inflate again. Repeat these operations until the beads are correctly seated.
- 14.** When all the previous operations have been correctly done, refit the valve core. Set the pressure according to the load: see tables in technical databook.
- 15.** Make sure the valves do not touch the rims, the brake drums or other fixed mechanical parts.

Removing

- Never try to unseat the beads of an inflated tyre.
- Always remove the valve core.
- Let the tyre deflate, check before unseating that the tyre is completely deflated. Never use tools that could damage the rims or the beads of the tyre.

Recommendations to extend the lifespan of a tyre

Tyre pressure

Correct inflation pressure is important for performance, durability, comfort and traction. It is of crucial importance for the life expectancy of your tyres that you adjust the tyre pressure according to usage and check it regularly. To ensure accurate measurement, the pressure gauge must be calibrated once a year. Measurement of tyre inflation pressure must be done when the tyres are cold. If the pressure in a warm tyre is correct, then it would be too low when the tyre has cooled.

Inflation pressure too low

Underinflation can reduce the lifespan due to:

- Damaged carcass cord plies, which can render the tyre unusable
- Increased wear
- Carcass damage close to the bead

Road use and operation in the field

These two kinds of usages require different tyre inflation pressures. Allowance has been made for this in the tyre pressure graphs. Radial and crossply tyres must not be used on the same axle, as this can lead to unstable handling.

Visual check

Tyres must be checked regularly for damage. Incision damage can be particularly harmful to the cord tissue layers of the tread.

Oil and grease

To avoid damage to the rubber, tyres should not come in contact with oil and grease.

Frost protection

To protect against frost when water ballasting, sufficient calcium chloride should be added. Please consult your supplier of calcium chloride about the right ratio.

Slippage of the tyre

The following can increase the likelihood of slippage of the tyre on the rim:

- Tyre pressure too low
- Faulty fitting of the tyre bead on the rim
- Overuse of lubricant when fitting a tyre
- Wrong rim size

The minimum tyre pressure for high-traction work (for example, ploughing) is 11.6 Psi when using an inner tube. A lower pressure increases the chances of the tyre turning on the rim and tearing off the valve.

Direction of steering wheels on four wheel drive tractors

When fitting or changing tyres ensure that the directional arrow on the sidewall is pointing forward. It is possible to fit the front tyres in such a way that the tread turns against the direction of rotation on four wheel drive tractors that are primarily used for transport activities. This will extend the lifespan of the tyres. Such fitting is not recommended for field activities, as it radically reduces traction and self-cleaning properties.

Transport instructions



Rim and Wheel Discs

A wheel is made up of a rim and a wheel disc that are fixed to or detachable from each other and must exactly match. The rim size is of crucial importance to the tyre/rim combination.

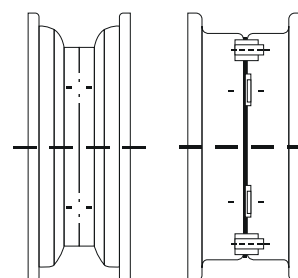

Size designations of rims

Two wheels are shown here with the associated meanings of the size indications.

Rim choice

When using tubeless tyres, tubeless rims should also be used. A protective flap must always be used when combining inner tubes with multipiece rims. This prevents damage to the inner tube.

Single rim	Multi-piece rim
4.00 E x 16	13 - 508
This means: 4.00 = rim width code (inches) E = rim flange height x = one piece rim 16 = rim diameter code (inches)	This means: 13 = rim width code (inches) - = rim flange height 508 = rim diameter code (inches)

The most important size indications of wheel discs are the following:

- G = diameter of the central hole
- S = pitch circle diameter of the stud holes and number of stud holes
- N = diameter cleat circle and number of cleats
- D = diameter stud hole and stud hole shape
- E = extra stud holes in case of double fitting
- B = outside diameter disc

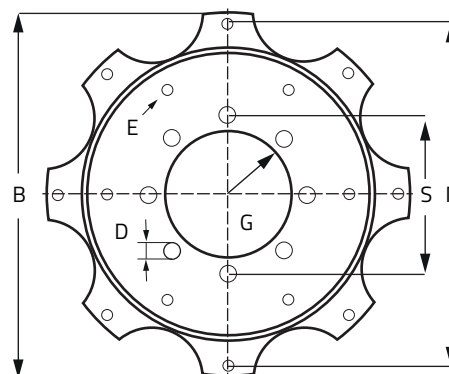

Warning

The diameter of different rim sizes may look very similar, but they're not equal as you can see in the table.

"Small" overall diameter		"Large" overall diameter	
Rim size code	Rim diameter D (mm)	Rim size code	Rim diameter D (mm)
430mm	430.9	17	436.6
15	380.2	15.3	388.3
508mm	508	20	512.8

Always use the rim stipulated

If you use a rim which is too narrow, the tread will be convex and, as is the case where tyre pressure is too high, there will be excessive wear of the centre of the tread. The fitting of a tyre to the wrong rim can lead to highly dangerous consequences! Fitting a "large" tyre (like 10.0/75-15.3) on a smaller rim (say rim size code 15) is dangerous. The tyre is loose-fitting and in extreme conditions can "blow-off" the ring. Rim chafing can be the consequence. Fitting a "smaller" tyre on a rim which is too large in overall diameter can also be dangerous! As the bead diameter of the tyre is smaller than the base rim flange diameter, by inflating the tyre, the chances of the bead breaking and the tyre exploding are high.

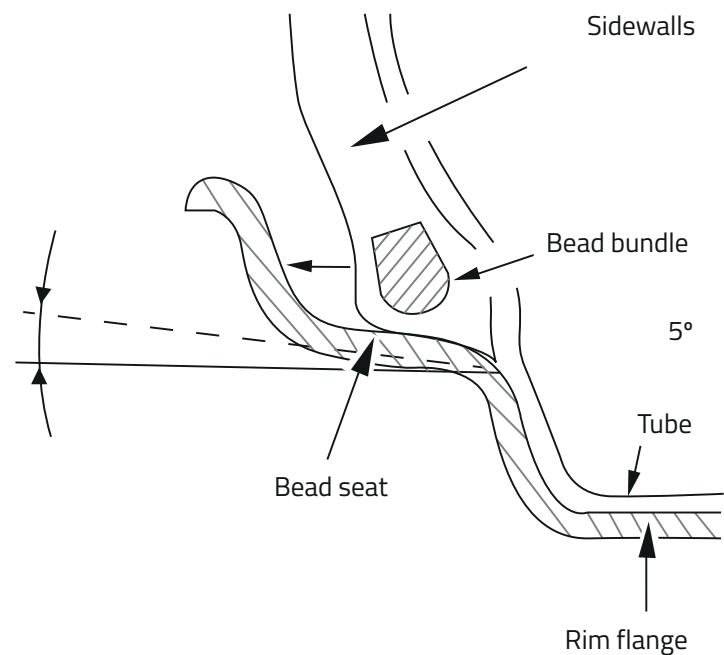

Sr. No	EAN Number	Application	Rim Diameter	Tyre Size	Pattern	PR	Type
1	8904365505298	TRACTOR	12	5-12.	TDB 121	6	TT
2	8904365505304			6-12.	TDB 121	6	TT
3	8904365505311		14	6-14.	TDB 121	4	TL
4	8904365501825			5.00-15	TSB 110	6	TT
5	8904365503867		15	9.5L-15 SL	TSB 112	8	TL
6	8904365503874			11L-15 SL	TSB 112	8	TL
7	8904365500422		16	4.50-16	TSB 111	6	TT
8	8904365502617			5.00-16	TSB 111	6	TT
9	8904365500323			5.50-16	TSB 110	6	TT
10	8904365500439			5.50-16	TSB 111	6	TT
11	8904365500330			6.00-16	TSB 110	6	TT
12	8904365500446			6.00-16	TSB 110	8	TT
13	8904365500453			6.00-16	TSB 111	8	TT
14	8904365505007			6.00-16	Boss TS 10	8	TT
15	8904365501832			6.50-16	TSB 110	6	TT
16	8904365505014			6.50-16	Boss TS 10	6	TT
17	8904365500460			6.50-16	TSB 111	8	TT
18	8904365500354			7.50-16	TSB 110	8	TT
19	8904365505021			7.50-16	Boss TS 10	8	TT
20	8904365501511			7.50-16	TSB 110	10	TT
21	8904365500477			7.50-16	TSB 111	8	TT
22	8904365500392			9.00-16	TSB 110	10	TT
23	8904365500408			10.00-16	TSB 110	10	TT
24	8904365503881			10.00-16 SL	TSB 112	8	TL
25	8904365500415			11.00-16	TSB 110	10	TT
26	8904365503898			11.00-16 SL	TSB 112	8	TL
27	8904365502747		8.00-16	TDB 120	6	TT	
28	8904365500378		18	7.50-18	TSB 110	8	TT
29	8904365500484			7.50-18	TSB 111	8	TT
30	8904365505328		9.5-18	TDB 121	8	TT	
31	8904365501849		19	4.00-19	TSB 110	6	TT
32	8904365500347			6.00-19	TSB 110	6	TT
33	8904365500491		6.00-19	TSB 111	8	TT	
34	8904365500507		20	6.50-20	TSB 111	8	TT
35	8904365500385			7.50-20	TSB 110	8	TT
36	8904365500514			7.50-20	TSB 111	8	TT
37	8904365502679			8.3-20	TDB 120	6	TT
38	8904365505335			8.3-20	TDB 121	8	TT
39	8904365502686			9.5-20	TDB 120	6	TT
40	8904365505342			9.5-20	TDB 121	8	TT
41	8904365502815			11.2-20	TDB 120	8	TT
42	8904365507735		11.2-20	TDB 120	8	TT	
43	8904365500095		24	8.3-24	TDB 120	8	TT
44	8904365500101			9.5-24	TDB 120	8	TT
45	8904365506431			9.5-24	TDB 120	12	TT
46	8904365505359			9.5-24	TDB 121	8	TT
47	8904365500118			11.2-24	TDB 120	8	TT/TL
48	8904365504772			11.2-24	TDB 120	12	TT
49	8904365500132			12.4-24	TDB 120	8	TT
50	8904365502068			12.4-24	TDB 120	12	TT
51	8904365505366			12.4-24	TDB 121	8	TT
52	8904365500156			13.6-24	TDB 120	8	TT
53	8904365504789			13.6-24	TDB 120	12	TT
54	8904365500187			14.9-24	TDB 120	8	TT
55	8904365501771			14.9-24	TDB 120	12	TT
56	8904365500217			16.9-24	TDB 120	8	TT

Sr. No	EAN Number	Application	Rim Diameter	Tyre Size	Pattern	PR	Type						
57	8904365501788	TRACTOR	26	16.9-24	TDB 120	12	TT						
58	8904365502822			14.9-26	TDB 120	10	TT						
59	8904365506448			14.9-26	TDB 120	12	TT						
60	8904365505373			13.6-26	TDB 121	8	TT						
61	8904365502839			16.9-26	TDB 120	10	TT						
62	8904365502532			23.1-26	TDB 123	12	TL						
63	8904365500521			23.1-26	TDB 123	16	TT/TL						
64	8904365500125			28	11.2-28	TDB 120	8	TT					
65	8904365500149				12.4-28	TDB 120	8	TT					
66	8904365504796				12.4-28	TDB 120	12	TT					
67	8904365505380				12.4-28	TDB 121	12	TT					
68	8904365504963				12.4-28	BOSS TD 15	12	TT					
69	8904365500170				13.6-28	TDB 120	8	TT					
70	8904365505397				13.6-28	TDB 121	12	TT					
71	8904365504970				13.6-28	BOSS TD 15	12	TT					
72	8904365500200				14.9-28	TDB 120	8	TT					
73	8904365502075				14.9-28	TDB 120	12	TT					
74	8904365505403				14.9-28	TDB 121	12	TT					
75	8904365504987				14.9-28	BOSS TD 15	12	TT					
76	8904365505410				16.9-28	TDB 121	12	TT					
77	8904365504994				16.9-28	BOSS TD 15	12	TT					
78	8904365500231				16.9-28	TDB 120	8	TT					
79	8904365502846				30	7.2-30	TDB 120	6	TT				
80	8904365502754					9.5-30	TDB 120	6	TT				
81	8904365502853					14.9-30	TDB 120	8	TT				
82	8904365500248					16.9-30	TDB 120	8	TT				
83	8904365501795					16.9-30	TDB 120	12	TT				
84	8904365505656					16.9-30	TDB 120	14	TT				
85	8904365500279					18.4-30	TDB 120	8	TT				
86	8904365501535					18.4-30	TDB 120	14	TT				
87	8904365501528					18.4-30	BOSS TD 15	14	TT				
88	8904365504802					18.4-30	TDB 120	16	TT				
89	8904365500545					32	8.3-32	TDB 120	8	TT			
90	8904365500163						12.4-32	TDB 120	8	TT			
91	8904365502761						9.5-32	TDB 120	6	TT			
92	8904365504208						24.5-32	TDB 124	12	TL			
93	8904365500262						34	16.9-34	TDB 120	8	TT		
94	8904365500293							18.4-34	TDB 120	8	TT		
95	8904365500194							36	12.4-36	TDB 120	8	TT	
96	8904365506455								12.4-36	TDB 120	14	TT	
97	8904365500224								13.6-36	TDB 120	8	TT	
98	8904365504819								13.6-36	TDB 120	12	TT	
00	8904365506462								13.6-36	TDB 120	14	TT	
100	8904365502358								38	13.6-38	TDB 120	8	TT
101	8904365504826									13.6-38	TDB 120	10	TT
102	8904365506479									13.6-38	TDB 120	14	TT
103	8904365500255									15.5-38	TDB 120	8	TT
104	8904365506004									15.5-38	TDB 120	10	TT
105	8904365506011									15.5-38	TDB 120	12	TT
106	8904365500286									16.9-38	TDB 120	8	TT
107	8904365504833									16.9-38	TDB 120	14	TT
108	8904365500309									18.4-38	TDB 120	8	TT/TL
109	8904365504840									18.4-38	TDB 120	14	TT
110	8904365502310									20.8-38	TDB 123	8	TT
111	8904365506578									20.8-38	TDB 123	14	TT

Sr. No	EAN Number	Application	Rim Diameter	Tyre Size	Pattern	PR	Type		
112	8904365503409	HARVESTER	26	23.1-26	HRB 210	16	TL		
113	8904365503966		32	30.5L-32	HRB 210	18	TL		
114	8904365506608	HARVESTER	10	7.50-10	IMB 160	12	TT		
115	8904365503188		12	12	10.0/80-12	IMB 160	10	TL	
116	8904365504093				6.5/80-12	IMB 162	6	TL	
117	8904365504086				7.00-12	IMB 162	6	TL	
118	8904365507407				320/60-12	IMB 166	132A8	TL	
119	8904365504239				23x8.50-12	IMB 165	6	TL	
120	8904365504192		26X12.00-12	IMB 165	8	TL			
121	8904365501856		14	9.5L-14	IMB 163	8	TL		
122	8904365503911		14.5	14.5	200/60-14.5	IMB 164	10	TT	
123	8904365503904				200/60-14.5	IMB 164	14	TT	
124	8904365503928				250/65-14.5	IMB 164	12	TL	
125	8904365504116		15	15	5.00-15	IMB 162	6	TL	
126	8904365506677				6.70-15SL	IMB 163	6	TL	
127	8904365504079				7.5L-15	IMB 162	8	TL	
128	8904365501863				7.60-15	IMB 163	10	TL	
129	8904365501443				9.5L-15SL	IMB 163	8	TL	
130	8904365501955				9.5L-15SL	IMB 163	12	TL	
131	8904365501450	11L-15SL			IMB 163	8	TL		
132	8904365501962	11L-15SL			IMB 163	12	TL		
133	8904365501603	12.5L-15SL			IMB 163	12	TL		
134	8904365504178	29X12.50-15			IMB 165	6	TL		
135	8904365504185	31x15.50-15	IMB 165	10	TL				
136	8904365501368	IMPLEMENT	15.3	10.0/75-15.3	IMB 160	10	TL		
137	8904365500552			10.0/75-15.3	IMB 160	14	TL		
138	8904365505687			10.0/75-15.3	IMB 160	18	TL		
139	8904365502501			11.5/80-15.3	IMB 160	10	TL		
140	8904365500569			11.5/80-15.3	IMB 160	14	TL		
141	8904365501092			11.5/80-15.3	IMB 160	16	TL		
142	8904365502709			12.5/80-15.3	IMB 160	18	TL		
143	8904365500576			12.5/80-15.3	IMB 160	14	TL		
144	8904365500897			260/70-15.3	IMB 161	10	TL		
145	8904365502181			260/70-15.3	IMB 161	14	TL		
146	8904365500903			10.0/75-15.3	IMB 162	10	TL		
147	8904365502716			10.0/75-15.3	IMB 162	14	TL		
148	8904365502723			10.0/75-15.3	IMB 162	18	TL		
149	8904365501108			11.5/80-15.3	IMB 160	18	TL		
150	8904365502730			11.5/80-15.3	IMB 162	14	TL		
151	8904365500910			11.5/80-15.3	IMB 162	12	TL		
152	8904365503249			300/80-15.3	IMB 161	14	TL		
153	8904365507391			15.5	15.5	280/60-15.5	IMB 166	128A8	TL
154	8904365502518					400/60-15.5	IMB 161	14	TL
155	8904365500927					400/60-15.5	IMB 161	16	TL
156	8904365506639					400/60-15.5	IMB 160	16	TL
157	8904365502525					400/60-15.5	IMB 161	18	TL
158	8904365504109			16	16	6.00-16	IMB 162	8	TL
159	8904365506660	6.50-16	IMB 162			8	TT		
160	8904365504161	7.50-16	IMB 162			8	TL		
161	8904365505038	9.00-16	Boss TR 20			16	TT		
162	8904365501870	9.00-16	Boss TR 20			18	TT		
163	8904365501474	12.5L-16SL	IMB 163			14	TL		
164	8904365503256	13.0/75-16	IMB 160			12	TL		
165	8904365507384	14.0/65-16	IMB 160			14	TL		
166	8904365504307	10.5/65-16	IMB 160			14	TL		
167	8904365500934	340/55-16	IMB 161			12	TL		
168	8904365501979	340/55-16	IMB 161	18	TL				

Sr. No	EAN Number	Application	Rim Diameter	Tyre Size	Pattern	PR	Type			
169	8904365503485	IMPLEMENT	16.1	16.5L-16.1	IMB 163	12	TL			
170	8904365503492			21.5L-16.1	IMB 163	14	TL			
171	8904365506615		17	17	15.0/55-17	IMB 160	10	TL		
172	8904365506622				15.0/55-17	IMB 160	14	TL		
173	8904365502143				380/55-17	IMB 161	10	TL		
174	8904365500941				380/55-17	IMB 161	14	TL		
175	8904365501986				380/55-17	IMB 161	18	TL		
176	8904365500958				480/45-17	IMB 161	14	TL		
177	8904365501993				480/45-17	IMB 161	18	TL		
178	8904365501597				500/50-17	IMB 161	10	TL		
179	8904365506653				500/50-17	IMB 160	14	TL		
180	8904365500965				500/50-17	IMB 161	14	TL		
181	8904365502006				500/50-17	IMB 161	18	TL		
182	8904365502556				19.0/45-17	IMB 162	10	TL		
183	8904365506646				19.0/45-17	IMB 160	14	TL		
184	8904365505731				19.0/45-17	IMB 162	16	TL		
185	8904365504154		18	18	7.50-18	IMB 162	8	TT		
186	8904365503263				10.5/80-18	IMB 160	14	TL		
187	8904365500972				13.0/65-18	IMB 160	16	TL		
188	8904365500989				15.0/70-18	IMB 160	16	TL		
189	8904365500996				12.5/80-18	IMB 160	16	TL		
199	8904365504123				10.5/80-18	IMB 162	10	TL		
200	8904365504130				12.5/80-18	IMB 162	12	TL		
201	8904365504147				20	20	7.50-20	IMB 162	8	TT
202	8904365506929						10.00-20	BOSS TR 21	18	TT
203	8904365502976						400/70-20	IMB 161	16	TL
204	8904365501580	500/55-20	IMB 161	10			TL			
205	8904365501009	500/55-20	IMB 161	12			TL			
206	8904365502327	IRRIGATION	24	11.2-24	IRB 260	6	TL			
207	8904365502334			14.9-24	IRB 260	8	TL			
208	8904365502341		38	11.2-38	IRB 260	6	TL			
209	8904365507414	FLOTATION	12	300/65-12	FTB 190	8	TL			
210	8904365501559		15.5	15.5	400/60-15.5	FTB 190	14	TL		
211	8904365501016				400/60-15.5	FTB 190	16	TL		
212	8904365505724				400/60-15.5	FTB 190	18	TL		
213	8904365507421		17	17	480/45-17	FTB 190	16	TL		
214	8904365502563				500/50-17	FTB 190	14	TL		
215	8904365502662		500/50-17	FTB 190	18	TL				
216	8904365502594		22.5	22.5	700/40-22.5	FTB 190	16	TL		
217	8904365501023				500/45-22.5	FTB 190	16	TL		
218	8904365501030				500/60-22.5	FTB 190	16	TL		
219	8904365505670				500/60-22.5	FTB 190	20	TL		
220	8904365501047				550/45-22.5	FTB 190	16	TL		
221	8904365502136				550/45-22.5	FTB 190	20	TL		
222	8904365503201				500/50-22.5	FTB 190	20	TL		
223	8904365504949				400/55-22.5	FTB 190	16	TL		
224	8904365501054				550/60-22.5	FTB 190	16	TL		
225	8904365503959				550/60-22.5 V	FTB 190	16	TL		
226	8904365502174				550/60-22.5	FTB 190	20	TL		
227	8904365501061				600/50-22.5	FTB 190	16	TL		
228	8904365503416	400/55-22.5	FTB 190	14	TL					
229	8904365502778	600/55-22.5	FTB 190	16	TL					
230	8904365502587	700/50-22.5	FTB 190	16	TL					
231	8904365502600	26.5	26.5	600/55-26.5	FTB 190	16	TL			
232	8904365502785			700/50-26.5	FTB 190	16	TL			
233	8904365502792			800/45-26.5	FTB 190	16	TL			
234	8904365500316			TELEHANDLER	20	405/70-20	THB 230	14	TL	

Sr.No	EAN Number	Application	Rim Diameter	Tyre Size	Pattern	PR	Type
235	8904365507742	TELEHANDLER	24	405/70-24	THB 230	14	TT
236	8904365501078			405/70-24	THB 230	14	TL
237	8904365501375			15.5/80-24	THB 230	12	TL
238	8904365505908			15.5/80-24 HD	THB 230 HD	12	TL
239	8904365501085			15.5/80-24	THB 230	16	TL
240	8904365505915			15.5/80-24 HD	THB 230 HD	16	TL
241	8904365505748	MULTI PURPOSE	26	23.1-26 <small>Dual Bead</small>	SPB 260	18	TL
242	8904365504468		30	620/75-30 (23.1-30) <small>Dual Bead</small>	SPB 260	16	TL
243	8904365506189			620/75-30 (23.1-30) <small>Dual Bead</small>	SPB 260	18	TL
244	8904365504727		32	650/75-32 (24.5-32) <small>Dual Bead</small>	SPB 260	16	TL
245	8904365504901			650/75-32 (24.5-32) <small>Dual Bead</small>	SPB 260	18	TL
246	8904365502549	AGRO FORESTRY	26	18.4-26	AFB 820	16	TL
247	8904365504925		24	12.4-24 <small>Steel Bead Cut-Resistant</small>	AFB 821	16	TL
248	8904365504932			13.6-24 <small>Steel Bead Cut-Resistant</small>	AFB 821	16	TL
249	8904365504888			14.9-24 <small>Steel Bead Cut-Resistant</small>	AFB 821	16	TL
250	8904365504857		30	16.9-30 <small>Steel Bead Cut-Resistant</small>	AFB 821	16	TL
251	8904365504871			18.4-30 <small>Steel Bead Cut-Resistant</small>	AFB 821	16	TL
252	8904365504864		34	16.9-34 <small>Steel Bead Cut-Resistant</small>	AFB 821	16	TL
253	8904365504895			18.4-34 <small>Steel Bead Cut-Resistant</small>	AFB 821	16	TL
254	8904365507360		LOG SKIDDER	26	18.4-26 <small>Steel Bead</small>	LSB 780	16
255	8904365505663	23.1-26 <small>Steel Bead</small>			LSB 780	16	TL
256	8904365506400	28L-26 <small>Steel Bead</small>			LSB 780	20	TL
257	8904365507377	32		24.5-32 <small>Steel Bead</small>	LSB 780	20	TL
258	8904365506486			30.5L-32 <small>Steel Bead</small>	LSB 780	20	TL
259	8904365506417			30.5L-32 <small>Steel Bead</small>	LSB 780	26	TL
260	8904365506424			30.5L-32 <small>Steel Bead</small>	LSB 780	32	TL
261	8904365507346			35.5L-32 <small>Steel Bead</small>	LSB 780	26	TL
262	8904365507353			35.5L-32 <small>Steel Bead</small>	LSB 780	32	TT
263	8904365505274			FORESTRY FORWADER	22.5	710/40-22.5 <small>Steel Bead</small>	FFB 840
264	8904365505922	26.5	600/55-26.5 <small>Steel Bead</small>		FFB 840	20	TT
265	8904365505939		710/45-26.5 <small>Steel Bead</small>		FFB 840	20	TT
266	8904365505946		800/40-26.5 <small>Steel Bead</small>		FFB 840	20	TT

EAN Number: Radial



Sr. No	EAN Number	Application	Rim Diameter	Tyre Size	Pattern	PR	Type
1	8904365506912	TRACTOR	20	250/85R20	TDR 850	116 D	TL
2	8904365503386			280/85R20	TDR 850	116 D	TL
3	8904365503393			320/85R20	TDR 850	119 D	TL
4	8904365502938		24	250/85R24	TDR 850	109D	TL
5	8904365501115			280/85R24	TDR 850	115D	TL
6	8904365501139			320/85R24	TDR 850	122D	TL
7	8904365501153			340/85R24	TDR 850	125D	TL
8	8904365501177			380/85R24	TDR 850	131D	TL
9	8904365501184		420/85R24	TDR 850	137D	TL	
10	8904365501122		28	280/85R28	TDR 850	118D	TL
11	8904365501146			320/85R28	TDR 850	124D	TL
12	8904365501160			340/85R28	TDR 850	127D	TL
13	8904365501382			380/85R28	TDR 850	133D	TL
14	8904365501207		420/85R28	TDR 850	139D	TL	
15	8904365502426		30	380/85R30	TDR 850	135D	TL
16	8904365501214			420/85R30	TDR 850	140D	TL
17	8904365501245			460/85R30	TDR 850	145D	TL
18	8904365501399		32	320/85R32	TDR 850	126D	TL
19	8904365505779			320/85R32	TDR 850	145D	TL
20	8904365502433		34	380/85R34	TDR 850	137D	TL
21	8904365501221			420/85R34	TDR 850	142D	TL
22	8904365504413			420/85R34 <small>Steel Belt, Scraper Guard</small>	TDR 850	152D	TL
23	8904365501252		460/85R34	TDR 850	147D	TL	
24	8904365501405		36	320/85R36	TDR 850	128D	TL
25	8904365503195			320/85R36	TDR 850	148D	TL
26	8904365501412			340/85R36	TDR 850	132D	TL
27	8904365502952		38	320/85R38	TDR 850	143D	TL
28	8904365502945			340/85R38	TDR 850	133D	TL
29	8904365501238			420/85R38	TDR 850	144D	TL
30	8904365501269			460/85R38	TDR 850	149D	TL
31	8904365507780			460/85R38	TDR 850	149D	TL
32	8904365501191		520/85R38	TDR 850	155D	TL	
33	8904365501429		42	520/85R42	TDR 850	157D	TL
34	8904365502471			520/85R42	TDR 850	165D	TL
35	8904365501436		46	520/85R46	TDR 850	158D	TL
36	8904365502488			520/85R46	TDR 850	169D	TL
37	8904365503355		20	360/70R20	TDR 700	129 D	TL
38	8904365503362			380/70R20	TDR 700	122D	TL
39	8904365501733		24	320/70R24	TDR 700	116D	TL
40	8904365501726			360/70R24	TDR 700	122D	TL
41	8904365501702			380/70R24	TDR 700	125D	TL
42	8904365501740			420/70R24	TDR 700	130D	TL
43	8904365507773			420/70R24 <small>Steel Belt, Scraper Guard</small>	TDR 700	130D	TL
44	8904365501665		480/70R24	TDR 700	138D	TL	
45	8904365501719		28	360/70R28	TDR 700	125D	TL
46	8904365501696			380/70R28	TDR 700	127D	TL
47	8904365501689			420/70R28	TDR 700	133D	TL
48	8904365501658			480/70R28	TDR 700	140D	TL
49	8904365501672		30	420/70R30	TDR 700	134D	TL
50	8904365501641			480/70R30	TDR 700	141D	TL
51	8904365501634		34	480/70R34	TDR 700	143D	TL
52	8904365504390			480/70R34 <small>Steel Belt, Scraper Guard</small>	TDR 700	157D	TL
53	8904365501610			520/70R34	TDR 700	148D	TL
54	8904365501627		38	480/70R38	TDR 700	145D	TL
55	8904365501764			520/70R38	TDR 700	150D	TL
56	8904365501757			580/70R38	TDR 700	155D	TL
57	8904365501924			580/70R38 <small>Steel Belt</small>	TDR 700	180D	TL

EAN Number: Radial



Sr. No	EAN Number	Application	Rim Diameter	Tyre Size	Pattern	PR	Type		
58	8904365502860	TRACTOR	38	380/80R38	TDR 800	142D	TL		
59	8904365504406			380/80R38	TDR 800	152D	TL		
60	8904365502198		42	480/80R42	TDR 800	156D	TL		
61	8904365502204		46	480/80R46	TDR 800	158D	TL		
62	8904365502211		50	50	480/80R50	TDR 800	159D	TL	
63	8904365502495				480/80R50	TDR 800	165D	TL	
64	8904365505830		20	20	420/65R20	TDR 650	135D	TL	
65	8904365505847				440/65R20	TDR 650	138D	TL	
66	8904365502273		24	24	480/65R24	TDR 650	140D	TL	
67	8904365502259				540/65R24	TDR 650	146D	TL	
68	8904365502808				440/65R24	TDR 650	135D	TL	
69	8904365505281		28	28	440/65R28	TDR 650	138 D	TL	
70	8904365502266				480/65R28	TDR 650	142D	TL	
71	8904365502242				540/65R28	TDR 650	149D	TL	
72	8904365502235		30	30	540/65R30	TDR 650	150D	TL	
73	8904365502228		34	34	540/65R34	TDR 650	152D	TL	
74	8904365502297				600/65R34	TDR 650	157D	TL	
75	8904365502303		38	38	540/65R38	TDR 650	153D	TL	
76	8904365502280				600/65R38	TDR 650	159D	TL	
77	8904365502365				650/65R38	TDR 650	163D	TL	
78	8904365504758				650/65R38	TDR 650	171 D	TL	
79	8904365502372				42	42	650/65R42	TDR 650	165D
80	8904365502440		28	28	600/65R28	XLR 880	154D	TL	
81	8904365502624				600/70R28	XLR 880	161D	TL	
82	8904365502457		30	30	600/70R30	XLR 880	152D	TL	
83	8904365504710		34	34	600/70R34	XLR 880	160D	TL	
84	8904365507797		38	38	650/85R38	XLR 880	173D	TL	
85	8904365502396				710/70R38	XLR 880	172D	TL	
86	8904365502402				710/70R38	XLR 880	178D	TL	
87	8904365502655				800/70R38	XLR 880	178D	TL	
88	8904365507650				650/75R38	XLR 880	144A8/169B	TL	
89	8904365502648				650/85R38	XLR 880	173D	TL	
90	8904365502464				42	42	710/70R42	XLR 880	173D
91	8904365507766		710/70R42	XLR 880			173D	TL	
92	8904365502631		620/70R42	XLR 880			166D	TL	
93	8904365502969		710/75R42	XLR 880			175D	TL	
94	8904365503270		COMPACT DRIVE	16	240/70R16	CDR700	104D	TL	
95	8904365503287				260/70R16	CDR700	109D	TL	
96	8904365503300				280/70R16	CDR 700	112D	TL	
97	8904365503317			18	18	280/70R18	CDR 700	114 D	TL
98	8904365503379					340/65R18	CDR 700	113D	TL
99	8904365503294			20	20	260/70R20	CDR 700	113 D	TL
100	8904365503324					280/70R20	CDR 700	116 D	TL
101	8904365503331					300/70R20	CDR 700	120 D	TL
102	8904365503348					320/70R20	CDR 700	123D	TL
103	8904365506370			30	30	420/90R30	TDR 900	147A8/147B	TL
104	8904365503447		32	32	270/95R32	TDR 900	136D	TL	
105	8904365503430	230/95R32			TDR 900	128D	TL		
106	8904365503508	36	36	230/95R36	TDR 900	130D	TL		
107	8904365503515			270/95R36	TDR 900	139D	TL		
108	8904365503522	38	38	270/95R38	TDR 900	140D	TL		
109	8904365506899			380/95R38	TDR 900	150A8/147D	TL		
110	8904365503539	42	42	270/95R42	TDR 900	139D	TL		
111	8904365503560	44	44	230/95R44	TDR 900	134D	TL		
112	8904365503546			270/95R44	TDR 900	142D	TL		
113	8904365503591	46	46	300/95R46	TDR 900	148D	TL		
114	8904365503614			320/90R46	TDR 900	148D	TL		

Sr. No	EAN Number	Application	Rim Diameter	Tyre Size	Pattern	PR	Type	
115	8904365504383	ROW CROP, SPRAYER	46	380/90R46 <small>Load Rating</small>	TDR 900	159D	TL	
116	8904365504352			380/90R46 <small>Load Rating</small>	TDR 900	173D	TL	
117	8904365503577		48	48	230/95R48	TDR 900	136D	TL
118	8904365503553				270/95R48	TDR 900	144D	TL
119	8904365503638		50	50	340/85R48	TDR 900	151D	TL
120	8904365503621				320/90R50	TDR 900	150D	TL
121	8904365506882		52	52	480/95R50	TDR 900	167A8/164D	TL
122	8904365503607				300/95R52	TDR 900	156D	TL
123	8904365503584		54	54	270/95R54 <small>Load Rating</small>	TDR 900	156D	TL
124	8904365506127				42	VF 580/85R42 <small>Load Rating</small>	VDR 900	183 D
125	8904365505786		46	46	VF 380/90R46 <small>Load Rating</small>	VDR 900	173D	TL
126	8904365506134				VF 520/85R46 <small>Load Rating</small>	VDR 900	173 D	TL
127	8904365506387		50	50	VF 320/90R50 <small>Load Rating</small>	VDR 900	169 D	TL
128	8904365506394				VF 380/90R50 <small>Load Rating</small>	VDR 900	175 D	TL
129	8904365507667		50	50	VF 420/95R50 <small>Load Rating</small>	VDR900	177D	TL
130	8904365506141				VF 480/80R50 <small>Load Rating</small>	VDR 900	179 D	TL
131	8904365507674		54	54	VF 480/95R50 <small>Load Rating</small>	VDR 900	176 D	TL
132	8904365505243				VF 320/90R54 <small>Load Rating</small>	VDR 900	168 D	TL
133	8904365507681		54	54	VF 380/105R54 <small>Load Rating</small>	VDR900	180 D	TL
134	8904365506905				46	VF 380/90R46 <small>Load Rating</small>	VDR 901	173 D
135	8904365507872		TRACTOR, TELEHANDLER	16	250/75R16 <small>Load Rating</small>	MDR 1000	120 G	TL
136	8904365506837	18		340/80R18 <small>Load Rating</small>	MDR 1000	143A8/138D	TL	
137	8904365506820	20		360/80R20 <small>Load Rating</small>	MDR 1000	147A8/143D	TL	
138	8904365506868	24		24	360/80R24 <small>Load Rating</small>	MDR 1000	143A8/138D	TL
139	8904365506356				400/80R24 <small>Load Rating</small>	MDR 1000	149A8/144D	TL
140	8904365506295	28		28	440/80R24 <small>Load Rating</small>	MDR 1000	154A8/149D	TL
141	8904365506332				400/80R28 <small>Load Rating</small>	MDR 1000	151A8/146D	TL
142	8904365506301	28		28	440/80R28 <small>Load Rating</small>	MDR 1000	156A8/151D	TL
143	8904365506349				480/65R28 <small>Load Rating</small>	MDR 1000	154A8/149D	TL
144	8904365506363	30		30	540/65R28 <small>Load Rating</small>	MDR 1000	160A8/155D	TL
145	8904365506318				440/80R30 <small>Load Rating</small>	MDR 1000	157A8/153D	TL
146	8904365506813	30		30	480/80R30 <small>Load Rating</small>	MDR 1000	162A8/157D	TL
147	8904365506783				540/65R30 <small>Load Rating</small>	MDR 1000	161A8/156D	TL
148	8904365506806	34		34	600/70R30 <small>Load Rating</small>	MDR 1000	171A8/166D	TL
149	8904365506325				440/80R34 <small>Load Rating</small>	MDR 1000	159A8/155D	TL
150	8904365506271	38		38	480/80R34 <small>Load Rating</small>	MDR 1000	164A8/159D	TL
151	8904365506288				480/80R38 <small>Load Rating</small>	MDR 1000	166A8/161D	TL
152	8904365507469	38		38	540/80R38 <small>Load Rating</small>	MDR 1000	172A8/167D	TL
153	8904365506790				600/65R38 <small>Load Rating</small>	MDR 1000	170A8/166D	TL
154	8904365506769	42		42	650/65R38 <small>Load Rating</small>	MDR 1000	175A8/170D	TL
155	8904365506776				650/65R38 <small>Load Rating</small>	MDR 1000	175A8/170D	TL
156	8904365507476	42	42	650/85R38 <small>Load Rating</small>	MDR 1000	183A8/178D	TL	
157	8904365506844			650/65R42 <small>Load Rating</small>	MDR 1000	176A8/171D	TL	
158	8904365506851	42	42	710/70R42 <small>Load Rating</small>	MDR 1000	185A8/180D	TL	
159	8904365505588			26	620/75R26	HRR 200	167 A8	TL
160	8904365505595	32	32	650/75R32	HRR 200	172 A8	TL	
161	8904365505601			800/65R32 <small>Load Rating</small>	HRR 200	181 A8	TL	
162	8904365505618	32	32	900/60R32 <small>Load Rating</small>	HRR 200	191 D	TL	
163	8904365505472			15	15	31X15.50R15	IMR 140	122 B
164	8904365505489	33X15.50R15	IMR 140			126 B	TL	
165	8904365507803	16.5	16.5	VF 280/70R15 <small>Load Rating</small>	VIR 2500	140 D	TL	
166	8904365507810			VF 320/70R15 <small>Load Rating</small>	VIR 2500	145 D	TL	
167	8904365507827	17	17	VF 380/55R16.5 <small>Load Rating</small>	VIR 2500	148D	TL	
168	8904365507834			VF 380/60R16.5 <small>Load Rating</small>	VIR 2500	147D	TL	
169	8904365505496	17	17	425/55R17	IMR 140	134 D	TL	
170	8904365505502			500/50R17 <small>Load Rating</small>	IMR 140	145 D	TL	
171	8904365505571	MULTI PURPOSE	18	355/60R18 <small>Load Rating</small>	MPR 390	142J	TL	

Sr. No	EAN Number	Application	Rim Diameter	Tyre Size	Pattern	PR	Type	
172	8904365505427	TRUCKS & GRASS TERRIANS	15	31X15.50R15	SPR 250	122 B	TL	
173	8904365505434			33X15.50R15	SPR 250	126 B	TL	
174	8904365505441		17	440/50R17 <small>Steel Beaded</small>	SPR 250	135 D	TL	
175	8904365505458			480/45R17 <small>Steel Beaded</small>	SPR 250	137 D	TL	
176	8904365505465			500/50R17 <small>Steel Beaded</small>	SPR 250	147 D	TL	
177	8904365503478	FLOTATION	17	500/50R17 <small>Steel Beaded</small>	FTR 170	149 D	TL	
178	8904365503089		22.5	560/45R22.5 <small>Steel Beaded</small>	FTR 170	152D	TL	
179	8904365506158			500/60R22.5 <small>Steel Beaded</small>	FTR 170	155 D	TL	
180	8904365503058			560/60R22.5 <small>Steel Beaded</small>	FTR 170	165D	TL	
181	8904365503423			600/50R22.5 <small>Steel Beaded</small>	FTR 170	159D	TL	
182	8904365506165		26.5	620/40R22.5 <small>Steel Beaded</small>	FTR 170	154 D	TL	
183	8904365503454			750/45R26.5 <small>Steel Beaded</small>	FTR 170	170 D	TL	
184	8904365503119			600/55R26.5 <small>Steel Beaded</small>	FTR 170	165D	TL	
185	8904365503072			710/50R26.5 <small>Steel Beaded</small>	FTR 170	170D	TL	
186	8904365503065			650/55R26.5 <small>Steel Beaded</small>	FTR 170	170D	TL	
187	8904365505793			650/55R26.5 <small>Steel Beaded</small>	FTR 170	178D	TL	
189	8904365506172			650/60R26.5 <small>Steel Beaded</small>	FTR 170	180 D	TL	
190	8904365505854		30.5	800/45R26.5 <small>Steel Beaded</small>	FTR 170	174D	TL	
191	8904365503461			710/50R30.5 <small>Steel Beaded</small>	FTR 170	176 D	TL	
192	8904365504314			750/60R30.5 <small>Steel Beaded</small>	FTR 170	181 D	TL	
193	8904365505861		LAWN AND GARDEN	12	850/50R30.5 <small>Steel Beaded</small>	FTR 170	182 D	TL
194	8904365507544				220/55R12	UTR240	82 A8/B	TL
195	8904365507612			240/60R12	UTR240	89 A8/B	TL	
196	8904365507551			14	220/55R14	UTR240	93 A8/B	TL
197	8904365507599	15		200/60R15	UTR240	83 A8/B	TL	
198	8904365507575	16		200/65R16	UTR240	94 A8/B	TL	
199	8904365507582			200/70R16	UTR240	94 A8/B	TL	
200	8904365507605			240/70R16	UTR240	104 A8/B	TL	
201	8904365507513			260/70R16	UTR240	109 A8/B	TL	
202	8904365507506	18		280/70R16	UTR240	112 A8/B	TL	
203	8904365507568			260/70R18	UTR240	114 A8/B	TL	
204	8904365507490	20		280/70R18	UTR240	114 A8/B	TL	
205	8904365507629		300/70R20	UTR240	110 A8/B	TL		
206	8904365507636	24	320/70R20	UTR240	113 A8/B	TL		
207	8904365507520		380/70R20	UTR240	122 A8/B	TL		
208	8904365507537	24	380/70R24	UTR240	125 A8/B	TL		
209	8904365507643		420/70R24	UTR240	130 A8/B	TL		

DRIVE ON **7** ***** YEAR WARRANTY

on Agriculture Radial Tyres

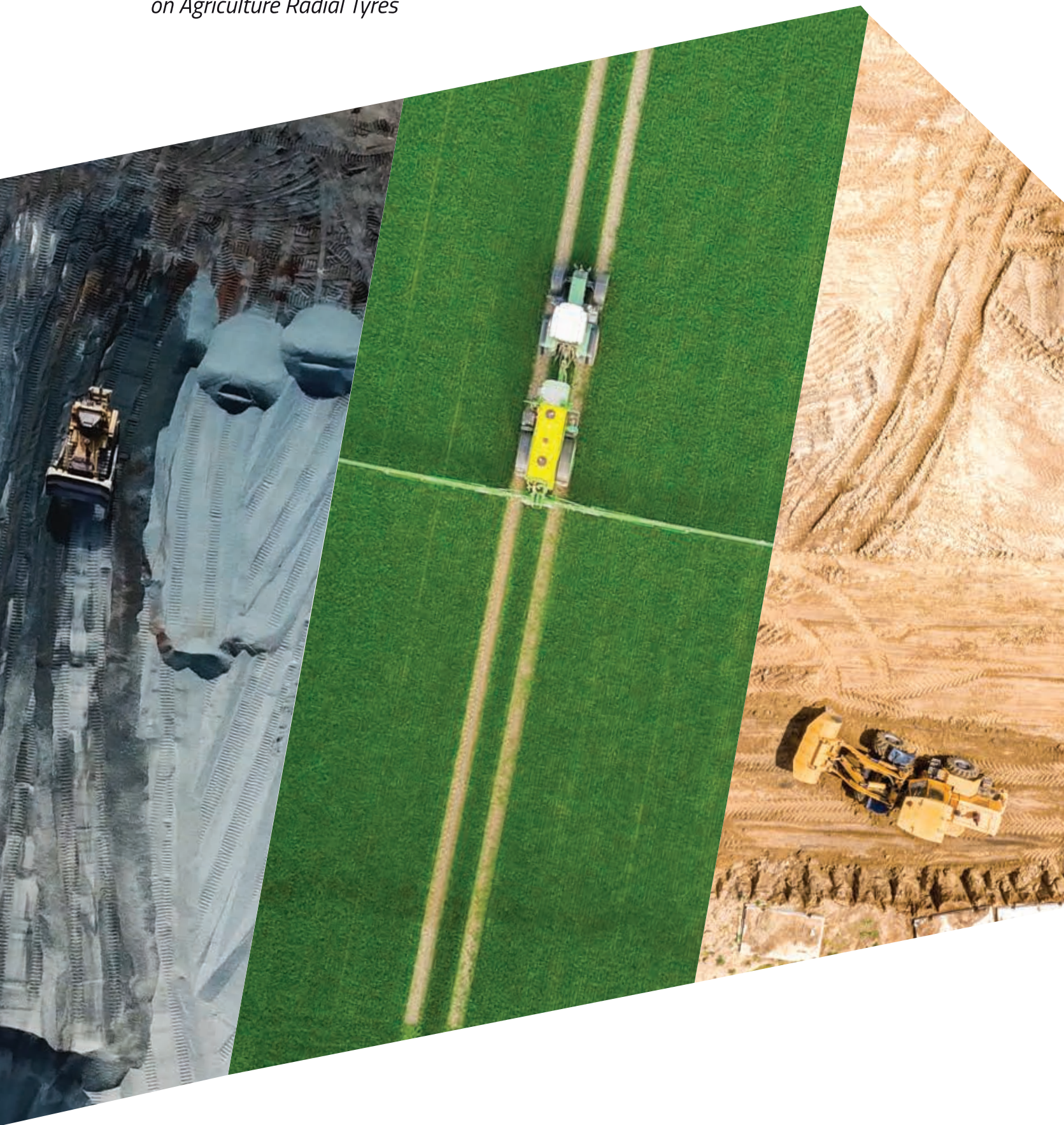

 **ASCENSO**
never stop rising

Ascenso International Warranty Policy for Agriculture Radial Tyres

This limited warranty covers ASCENSO branded Agriculture Radial tyres that are sold in Europe, Australia, New Zealand, Asia Pacific, Middle East, Africa and Latin America Markets, are manufactured on or after April 1, 2020 and meet the following criteria:

1. Tyres that bear the name ASCENSO and the complete DOT codes, molded on the sidewall.
2. Products with at least 2mm of tread remaining.
3. The replacement percentage will be multiplied by the original purchase price of the tyre (excluding any taxes or duties) to determine the amount of reimbursement to be applied. Such reimbursement must be applied towards the purchase price of the replacement tyre in effect at the time of adjustment.
4. Tyres that are not more than 7 years old. The years will be counted from the date of invoice (dealer's invoice to the end user) or from the month of production in case of non-availability of an invoice.
5. Tyres that were used strictly in accordance with the recommendations of the applicable vehicle manufacturer and ASCENSO standard maintenance and safety recommendations, in normal agricultural service.
6. Defects established by ASCENSO personnel will only qualify for warranty and it will cease once the tyres are repaired.
7. The customer will be responsible for all other charges including taxes, mounting, field service and other charges such as applicable freight.
8. The age of a tyre will be determined by a sales invoice showing the date of purchase. If a proof of purchase is not available, the age of a tyre will be determined from the date of manufacture, moulded on the sidewall.
9. This warranty coverage is for tyres used in normal applications and any use outside specifications automatically voids this warranty.
10. All adjusted tyres will be disabled, and their DOT codes will be removed. The customer will be responsible for disposal of the adjusted tyres.
11. If a tyre in normal agricultural services becomes unserviceable within the time or tread-wear periods shown below, it will be replaced with a comparable new ASCENSO tyre according annexure A mentioned below

Scope Of Warranty

Annexure-A

The limited warranty is available within certain age limits i.e. within certain number of month(s) from production or sale. Any adjustment will be based on the remaining tread depth or services life whichever is less, this warranty policy covers product described under the eligibility criteria.

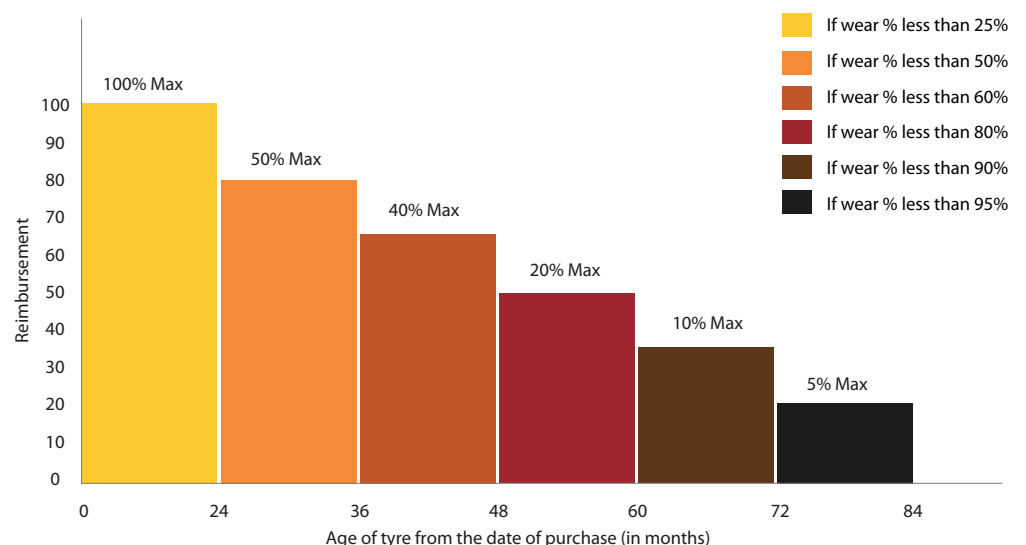

* If a tyre's purchase month or service cannot be accurately determined, then the date of manufacture will be considered for replacement.
* Agriculture Tyres include Tractor Radial, Flotation Radial and Agro Industrial Radials.
* If the tyre wear is more than above mentioned for each period, % credit will be calculated on pro-rata basis of the remaining tread depth.

Limitations

1. This limited warranty is applicable to the original purchaser and is not assignable to any subsequent owner.
2. Any tyre, no matter how well manufactured, may fail in service or become unserviceable due to conditions beyond our control.
3. This limited warranty is under no circumstances a representation that a tyre failure cannot occur.
4. No ASCENSO dealer, agent, or representative has the authority to make any representation, promise, or agreement which, in any way, varies, alters or enhances the terms of this warranty.
5. This warranty ceases once the tyres are repaired.

Failures Not Covered

- This warranty does not cover:
 1. Damage resulting from misuse, improper mounting, misapplication, use of non-approved rims, improper inflation, improper repair, overloading, running on a flat tyre, misalignment or imbalance of wheels/rims, defective brakes or shock absorbers, abuse, wilful damage, oil, chemical reaction, fire or other externally-generated heat, use of studs, water or other materials trapped inside the tyre.
 2. Claims for irregular or rapid tread-wear
 3. Full service rendered, repaired or retread tyres
 4. Any modifications to the tyre (like added buttress shoulders, retreading, regrooving)
- Any material added to the tyre (like tyre fill, sealer, balancer) is not covered by this limited warranty and will not be compensated for under the provisions of this warranty.



Disclaimer & right to change the policy

When detailed information and/or decisions are required in order to implement/ interpret this policy, Ascenso can add and/or change such detailed information and/or decisions to this policy as "conditions" at any time. Ascenso reserves the right to change policy term and conditions from time to time at its sole direction.

DRIVE ON **5**★ ★ ★ ★ ★ YEAR WARRANTY

on all Bias Tyres

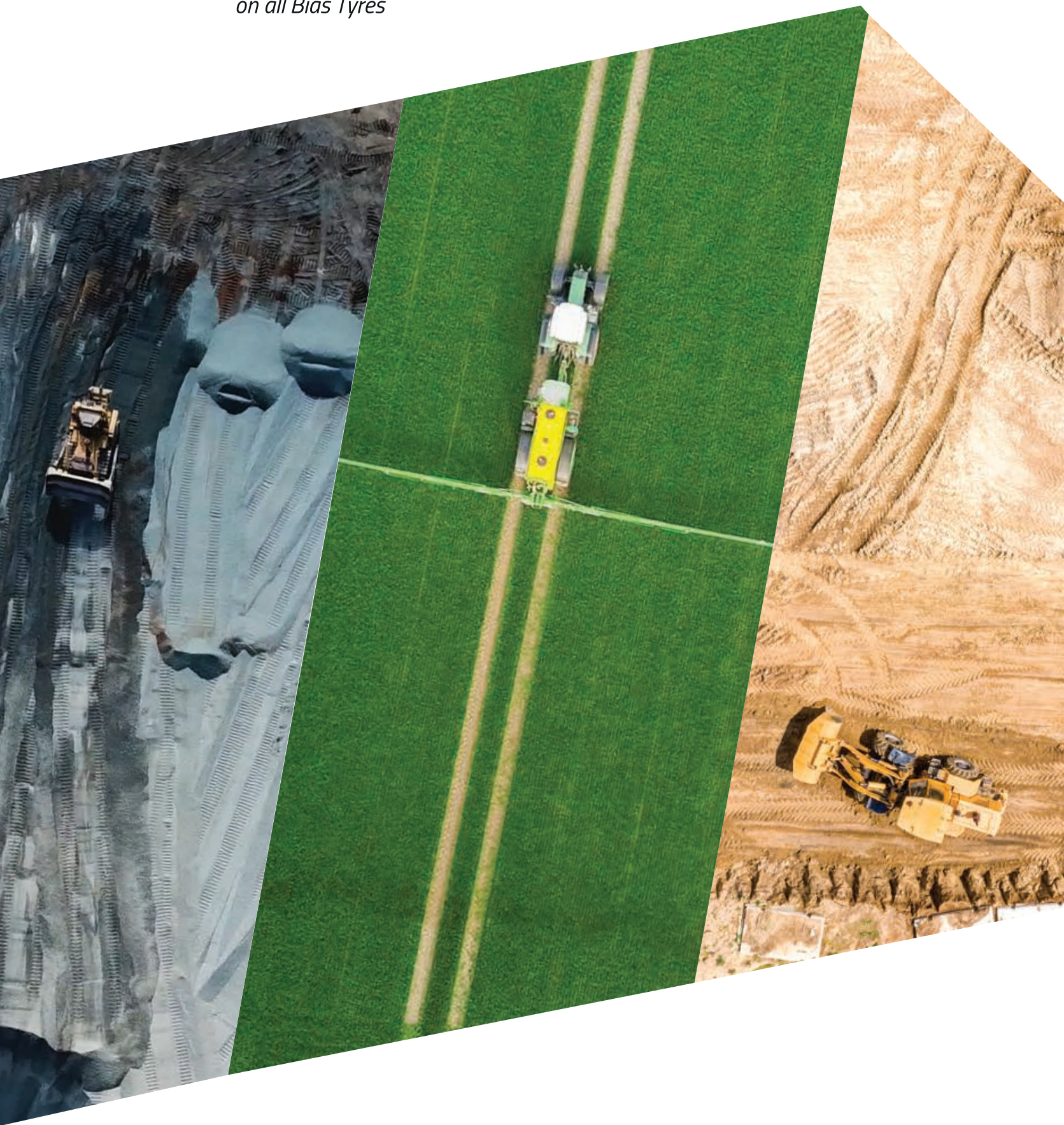

 **ASCENSO**
never stop rising

Ascenso International Warranty Policy for all Bias Tyres

Limited warranty

This limited warranty covers ASCENSO branded Bias tyres that are sold in Europe, Australia, New Zealand, Asia Pacific, Middle East, Africa and Latin America Markets, are manufactured on or after April 1, 2020 and meet the following criteria:

Eligibility

- Every tyre bearing the name ASCENSO and with a complete DOT codes moulded in the sidewall is warranted to be free from manufacturing defects within the manufacturer's control.
- Products with at least 2 mm of tread remaining.
- The replacement percentage will be multiplied by the original purchase price of the tyre (excluding any taxes or duties) to determine the amount of reimbursement to be applied. Such reimbursement must be applied towards the purchase price of the replacement tyre in effect at the time of adjustment.
- All adjusted tyres will be disabled, and the DOT codes will be removed. The customer is responsible for the disposal of all adjusted tyres.
- This warranty coverage is for tyres used within published design specifications for ASCENSO tyres. Any use outside such specifications automatically voids the warranty. Please consult ASCENSO data books or maintenance manuals for design specifications.
- This warranty does not apply to used or 'NA' (not adjustable) tyres.
- If an examination by an authorized ASCENSO representative shows that any such tyre failed as a result of manufacturing defects, either it will be, at the option of ASCENSO, repaired at no charge or a reimbursement will be issued towards the purchase price of a replacement tyre being comparable with the ASCENSO product. This reimbursement will be determined by applying the lesser of the percentage of remaining tread depth (RTD%) and the maximum age-based reimbursement shown in the graph displayed below.

Bias Agriculture, Industrial & Earthmover tires:

amount of credit to customer for manufacturing defects

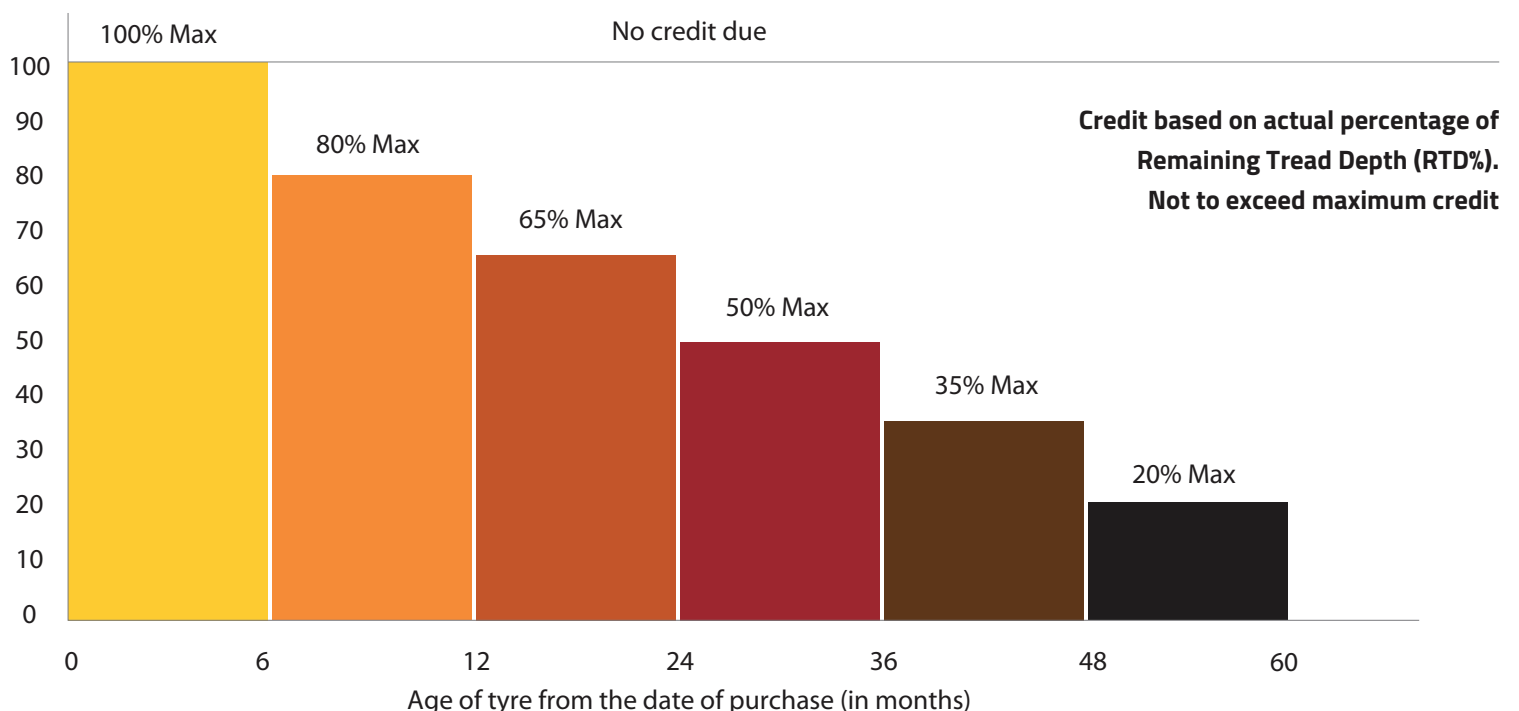

Time period

This warranty applies to a maximum period of 5 years (60 months) from the date of purchase of a tyre. If no invoice or documentation of the purchase can be provided, the date of manufacture will be used to determine the warranty.

Limitations

- This limited warranty is applicable to the original purchaser and is not assignable to subsequent purchasers.
- No ASCENSO dealer, agent, or representative has the authority to make or imply any representation, promise or agreement which in any way varies or extends the terms of this warranty.
- Any tyre, no matter how well manufactured, may fail in service or become unserviceable due to conditions beyond the control of the manufacturer.
- This limited warranty is under no circumstances a representation that a tyre failure cannot occur.
- To the extent that the provisions of any applicable legislation expressly replace, eliminate, amend or prohibit any term or terms contained herein, such term or terms shall be accordingly replaced, eliminated, amended or extended, as the case may be, in accordance with such legislation.

Limited warranty exclusions

All tyre warranties are subject to the following exclusions:

1. Tyres purchased after 60 months from the date of manufacture.
2. Tyres for which alternative warranties or guarantees have been negotiated.
3. Tyres used under chains. ASCENSO does recognize that in many applications tyre chains provide enhanced tyre protection and may extend the tyre life. In these cases, ASCENSO may extend special negotiated warranties. Please consult your ASCENSO Off Road Tyre Division representative for details.
4. Damage resulting from misuse, improper mounting, misapplication, use of non-approved rims, improper inflation, overloading, running on a flat tyre, misalignment or imbalance of wheels/rims, defective brakes or shock absorbers, abuse, wilful damage, oil, chemical action, fire or other externally-generated heat, use of studs, water or other material trapped inside the tyre, vehicle damage or road hazards (such as rock cuts, punctures, cut separations, impacts, flex breaks).
5. Claims for irregular wear or rapid tread wear.
6. Any tyre which is operated above its ton-mile-per hour (TMPH) or ton-kilometre-per hour (TKPH) rating.
7. Tyres mounted with non-approved tubes or O-rings.
8. Used, repaired or retread tyres.
9. Any modifications to the tyre (like added buttress shoulders, regrooving, relugging).
10. Any material added to the tyre (like tyre fill, sealer, balancer).
11. Use of a solid type fill (such as urethane).



Disclaimer & right to change the policy

When detailed information and/or decisions are required in order to implement/ interpret this policy, Ascenso can add and/or change such detailed information and/or decisions to this policy as "conditions" at any time. Ascenso reserves the right to change policy term and conditions from time to time at its sole direction.

Limited warranty exclusions

12. Any costs associated with the repair of tyres (unless previously approved by ASCENSO).
13. Costs of mounting and balancing following pro-rated replacement or repair of tyres or tubes, and applicable federal, state, provincial, and local taxes.
14. Cost of disposal of warranted tyres. Disposal of tyres is the sole responsibility of the customer.
15. All other warranties, including the implied warranties of merchantability and fitness for a particular purpose, are expressly disclaimed to the extent permitted by law.
16. All obligations or liabilities for indirect, incidental, punitive or consequential damage are hereby excluded to the extent permitted by law, including economic loss, loss of profit, loss of use of vehicle, loss of time, personal injury or death.

Some jurisdictions do not allow limitations in how long an implied warranty lasts, or the exclusion or limitation of incidental or consequential damages; so the above limitations or exclusions may not apply to you.

To obtain the warranty service:

1. Contact an authorized ASCENSO dealer or representative. Please be prepared to provide a proof of purchase of the product and a purchase date.
2. The authorized dealer or representative will contact ASCENSO to arrange the inspection of the tyre in question and processing of your claim. The dealer has no authority or responsibility to make the determination as to eligibility for coverage under this warranty.



Disclaimer & right to change the policy

When detailed information and/or decisions are required in order to implement/ interpret this policy, Ascenso can add and/or change such detailed information and/or decisions to this policy as "conditions" at any time. Ascenso reserves the right to change policy term and conditions from time to time at its sole direction.



Our philosophy to conserve and protect natural resources for future generations through environmental stewardship



Mahansaria Tyres Pvt. Ltd.
3rd Floor, Peninsula Chambers, Ganpat Rao Kadam Marg,
Lower Parel West, Mumbai 400013, India
T: +91 22 4348 1600
E: enquiry@ascensotyres.com
W: www.ascensotyres.com



Please sign and stamp inside the box

Distributor/Dealer